

BLOCK ROOM PRODUCTS & ACCESSORIES

HUESTIS STYRO-FORMER®



Quick Change Wire System



Convenient Power Lift LT Controls



869-160 Styro-Former® with Power Lift LT

The manual lift is a rotating friction drive and calibrated tie-rod system to adjust the source point and block tray position.

Quick, Smooth Operation

- Spring-loaded, Teflon tracing stylus moves freely in every direction
- Unhampered by limitations of an X or Y axis for complete maneuverability
- Can be adjusted to any treatment machine for universal application
- Work area remains stationary at a comfortable desktop working height
- Free-standing table and calibrated column can be placed in almost any small area without wall attachment

Standard Foam Block Holders

Included holders position standard 8", 10", or 12" foam blocks.

Power Lift LT

- Drive controls are panel mounted for quick, push-button height adjustments
- Position measurements are easily read directly from the vertical column
- Easily adjustable thumb screws allow quick cutting wire changes
- Wire measuring template included
- Convenient storage bin holds up to three tracing tips

Auto Boost Option

- Automatically boosts wire temperature to adjust for wire deflection
- Simple switching system reroutes the current through another circuit with its own potentiometer
- Can be pre-set to minimize distortion and maximize productivity
- Inexperienced operators can have limits set by supervisor
- Audio/visual alarm warns when too much pressure is applied by operator

Specifications

Electrical: 120 Vac, 60 Hz, 5 A

Table Size: 33.5" W x 24" D x 29.5" H (85.1 x 60.9 x 74.9 cm)

Column Height: 8.75' (2.67 m)

The Styro-Former® is FDA registered and CE certified.

Item	Description
869-100	Huestis Styro-Former®
869-110	Huestis Styro-Former® with Auto Boost
869-160	Huestis Styro-Former® with Power Lift LT
869-162	Huestis Styro-Former® with Power Lift LT and Auto Boost

Renowned as the worldwide industry standard, more Styro-Formers® are in use than all other shielding block mold cutters combined. Styro-Former® offers accurate, easy and fast cutting with minimal training. A hand-held tracing stylus allows quick radiograph outlining to provide a smooth and efficient block cutting procedure.

Styro-Former® Power Lift LT features panel-mounted drive controls for both source and block arm distances. A quick change wire system uses unique thumb screws and a table-mounted measuring template for quick, easy wire changes.

Accurate Cutting

- Manual tracing produces smooth, accurate cuts with minimal training
- Accurate cuts save time and material
- Verification light included

Rigid Box Frame

- Short cutting wire is kept tight in a rigid box frame to eliminate bowing
- Never necessary to apply downward pressure to keep the wire tight
- Rigid box frame ensures that cutting wire is precisely aligned between the source point and the block tray
- Nichrome cutting wire fits into the frames unique electro-mechanical bushings
- Bushings hold wire with a flat grip, for long wire life and easy wire changes
- Free cutting wire for life of machine

ALIGNMENT SYSTEM

For Huestis Styro-Former

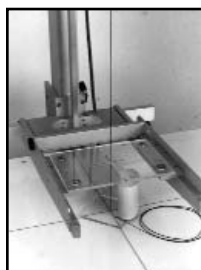

The Alignment System will check the target to film alignment with the block tray moving over its entire range.

Item #	Description
869-180	Alignment System For Huestis Styro-Former

BLOCK ROOM PRODUCTS & ACCESSORIES

COMPU-CUTTER® III



- Cutter is safely enclosed in cutting bay.
- Adjustable temperature for variations in foam densities.
- Safety interlock for open door position.
- Custom defaults: S.F.D., S.A.D., S.T.D.
- Distance changes can be factored in after digitizing or TPS import.
- Determines smallest block required for shape or combination of shapes.
- System can accommodate from 8"x8" to 12"x12" size blocks.

Versatile Configurations

- Our full system for the Compu-Cutter® III includes the cutter, computer, custom software, printer, digitizer and an optional label printer.

Easy Installation

- Footprint is smaller than our Styro-former®.
- Size: 15.75" W x 30" D x 30" H (40 x 76.2 x 76.2 cm)
- Weight: Approximately 60 lb (27.27 kg)
- Electrical Requirements: 120 VAC, 60 Hz, 10A (Optional 220 VAC, 50 Hz, 5A)

Modular Design

Designed for versatility, our stand-alone cutting bay is supplied as a fully integrated system.

Extremely Accurate

Fully articulating and gimballed cutting mechanism is accurate ± 1 mm at the block tray level for precise, divergent cuts.

Compu-cutter® III Digital Versatility

Operators can easily transfer digitized block outlines from treatment planning systems or may trace radiographs with a digitizing mouse. The outline is visible on the monitor and can be sent to the printer for examination of the printout, or to the hot wire cutter for block cutting. Operator may select any cut path to connect multiple block outlines.

Ensured Accuracy

Multiple verification checks include a paper printout to verify the tracing and a second paper template to mount the shielding block on a lexan tray.

User friendly

Characteristics include Windows® compatibility allowing for easy image manipulation, correction and cutting.

Versatile Configurations

Modular design includes standalone cutting bay, computer, monitor, printer and digitizer.

Compu-Cutter III™ Block Cutting System Includes

- Automatic 4 axis computer driven hot wire cutter including beam divergence.
- Data collection can be obtained directly from radiograph via digitizer.
- Import of patient information provided through interface with the most common Treatment Planning Systems.
- Free standing, back-lit digitizer.
- Printer (for verification purposes)
- Computer System with a Pentium processor, network card and flat panel monitor.
- Windows XP Operating System and Huestis Custom Software with drawing package feature that allows for easy manipulation and correction of images.
- System includes electron beam capability.
- 1 Carton (52pcs), 8" X 8" X 3" foam blocks
- System may be vented to atmosphere. Fan is included.
- Electrical requirement: 120 VAC / 220 VAC
- Product is CE marked.
- CBC DICOM, DICOM-RT interface

Item	Description
868-000	Compu-Cutter® III, 120 VAC
868-005	Compu-Cutter® III, 220 VAC

Radiotherapy departments can now take advantage of the cost savings and versatility of a compact tabletop Compu-cutter® system. The Compu-cutter® III is less than half the size of its predecessor without sacrificing quality and accuracy. Available as a complete package or as a single unit which can plug and play with your existing configuration. Huestis software is compatible with any Windows® based O/S, allowing for easy image manipulation, correction and cutting. The Compu-cutter® III is a CE certified radiotherapy shielding block cutter.

Precision Accuracy

- Computerized, four-axis cutter ensures accuracy of ± 1 mm.
- Built-in checks minimize operator error and time consuming re-cuts.
- Allows review of outline on monitor.
- Drawing package feature allows for easy image manipulation and correction.
- Cut path simulation prior to actual block cut.
- All functions and set ups are completely computer controlled.
- Radiograph printout verifies tracing.
- Template printout facilitates mounting shielding block on tray.

Treatment Planning Interfaces

- Digitized block outlines can be easily transferred from treatment planning.
- Eliminates redundant input of block outlines from radiographs.
- Imported outlines may be cut immediately or stored for later use.

Radiograph Digitizing (optional)

- Radiograph is aligned on crosshairs and traced with a digitizing mouse.
- Windows® based program digitizes and stores data and patient files for easy reference or modifications.
- Easy input of patient/block information.
- Pre-set operational function keys.
- User may select any cut path to connect multiple block outlines.

Quick Modifications

- Ability to "flip" image for fast AP/PA or L/R lateral blocks, or change any parameter without re-digitizing.

Hot Wire Cutting

- Image can be moved to any position on the block to allow for the conservation of styrofoam use.
- Fast 0.45 in/sec (1 cm/sec) cut speed.

BLOCK ROOM PRODUCTS & ACCESSORIES

FOAM CUTTER WITH ADJUSTABLE HEAT



- On/Off switch
- Electronic variable temperature control knob.
- Lockable feed bar/fence for angle cuts.
- One spool of NiChrome wire, 0.008" diameter x 98 ft L
- One year warranty

Includes: Hotwire Cutter, Miter Guide, Fence/Feed Bar, Spool of Wire, and Users Guide.

Specifications

Transformer Secondary Volts: 10V at 1.0A (Double Insulated)

Cutting Wire Temperature: 210 - 390°F (100 - 200°C)

Worktable Size: 15 3/8" x 11" (390 x 280mm)

Throat: 13 3/4" (350mm)

Cutting Height: 5 1/2" (140mm)

NiChromeWire: 0.008" dia. x 98 Ft (0.02 cm x 30 m)

Voltage: Item 869-910 - 110-120V AC, 60 Hz, 1 Amp, 50/60 Hz
Item 869-912 - 230V, 50/60 Hz, 20 watt

Weight: 6.6 lb (3 kg)

Item 869-912: CE marked

Item	Description
869-910	Foam Cutter w/Adjustable Heat, 110-120V
869-9101	NiChrome Wire, 0.008" Dia. x 98 ft. on spool
869-912	Foam Cutter w/Adjustable Heat, 230V, 50/60Hz

- A slippery work surface that is Alu Corbond compound making it easier to push Styrofoam around the large table.
- Very fine cut
- Solid aluminum overarm.
- The holder and wire spool may be shifted and adjusted along the overarm to enable miter cutting.
- An LED indicates operation and thus reminds you not to touch the hot wire to prevent burnt fingers (the wire heats to the maximum temperature in less than 1 second).
- Printed grid and protractor on worktable assist with division and cutting.

ELECTRON BLOCK FOAM CUTTER



The Electron Block Foam Cutter's white formica cabinet includes a lighted power switch and an 8' grounded power cord. The unit has an easily replaceable nic-chrome cutting wire. Recommended maximum Styrofoam thickness is 1" (2.54 cm)

Specifications

Size: 11 3/4" W x 14" L x 7" H

Weight: 8 lbs

Item #	Description
869-900	Electron Block Foam Cutter Power: 110 VAC, 50/60 Hz & 3 Amp
869-902	Electron Block Foam Cutter Power: 220/240 VAC, 50/60 Hz, 1.5 Amp
869-903	Replacement Wire for Electron Block Foam Cutter

EBC-2000 ELECTRON BLOCK CUTTER



The EBC-2000 Electron Block Cutter is a manual tabletop cutter for electron block cutouts. It provides clean hot wire cutting of radiotherapy foam shapes with no divergence angle. It is capable of cutting foam blocks from 1cm thick to 3 inches thick. This unit is also easily field convertible to be used with 120 or 220VAC power so there is no need to order a special unit.

Specifications

Size: 12" W x 16.5" L x 9.9" H (30.48x41.9x25.1 cm)

Weight: 10 lb (4.5 kg)

Item	Description
869-920	EBC-2000 Electron Block Cutter

BLOCK ROOM PRODUCTS & ACCESSORIES

NIC-CHROME CUTTING WIRE



The Nic-chrome Cutting Wire is 26 gauge x 10' long. It is used with the styroformers.

Item #	Description	Quantity
875-026	Nic Chrome Cutting Wire	1
875-026-6	Nic Chrome Cutting Wire	6

STYROFOAM BLOCKS



The Dow Chemical 25 and 30 PSI Styrofoam Blocks have planed flat top and bottom surfaces. This extremely smooth surface, when placed against a flat Cooling Plate, does not allow the alloy to leak out when filling the styrofoam.

Item #	Block Size	PSI	Quantity
870-708	3/4" x 8" x 8" (1.9 x 20.4 x 20.4 cm)	25	48
870-708-12	3/4" x 8" x 8" (1.9 x 20.4 x 20.4 cm)	25	12
870-710	3/4" x 10" x 10" (1.9 x 25.5 x 25.5 cm)	25	36
870-710-12	3/4" x 10" x 10" (1.9 x 25.5 x 25.5 cm)	25	12
870-711	3/4" x 11.5" x 11.5" (1.9 x 29.3 x 29.3 cm)	25	60
870-711-12	3/4" x 11.5" x 11.5" (1.9 x 29.3 x 29.3 cm)	25	12
871-008	1" x 8" x 8" (2.5 x 20.4 x 20.4 cm)	25	48
871-008-12	1" x 8" x 8" (2.5 x 20.4 x 20.4 cm)	25	12
871-010	1" x 10" x 10" (2.5 x 25.5 x 25.5 cm)	25	36
871-010-12	1" x 10" x 10" (2.5 x 25.5 x 25.5 cm)	25	12
871-012	1" x 12" x 12" (2.5 x 30.6 x 30.6 cm)	25	96
871-012-12	1" x 12" x 12" (2.5 x 30.6 x 30.6 cm)	25	12
872-008	2" x 8" x 8" (5 x 20.4 x 20.4 cm)	25	72

Item #	Block Size	PSI	Quantity
872-010	2" x 10" x 10" (5 x 25.5 x 25.5 cm)	25	36
872-010-12	2" x 10" x 10" (5 x 25.5 x 25.5 cm)	25	12
873-008	2.83" x 8" x 8" (7.6 x 20.4 x 20.4 cm)	30	72
873-008-12	2.83" x 8" x 8" (7.6 x 20.4 x 20.4 cm)	30	12
873-010	2.83" x 10" x 10" (7.6 x 25.5 x 25.5 cm)	30	48
873-010-12	2.83" x 10" x 10" (7.6 x 25.5 x 25.5 cm)	30	12
873-012	2.83" x 12" x 12" (7.6 x 30.6 x 30.6 cm)	30	32
873-012-12	2.83" x 12" x 12" (7.6 x 30.6 x 30.6 cm)	30	12
874-807	2.83" x 7 5/8" x 7 5/8" (7.6 x 19.4 x 19.4 cm)	30	72
874-807-12	2.83" x 7 5/8" x 7 5/8" (7.6 x 19.4 x 19.4 cm)	30	12
874-811	2.83" x 11.5" x 11.5" (7.6 x 29.3 x 29.3 cm)	30	32
874-811-12	2.83" x 11.5" x 11.5" (7.6 x 29.3 x 29.3 cm)	30	12

BLOCK ROOM PRODUCTS & ACCESSORIES

DIGITAL ALLOY DISPENSERS

For High (203°F) and Low (158°F) Melting Alloy



878-158 shown attached to 878-060

- Alloy Temperature Stability $\pm 4^\circ$
- Microprocessor PID Temperature Control
- "J" Thermocouple
- Open Thermocouple Sensor Will Shut Unit Down
- Over Temperature Bi-Metal Disc Thermostat
- Temperature is Displayed in Fahrenheit or Celsius
- Easy View Temperature Controls
- Set Point Reading Is Green and Alloy Temperature Is Red
- Insulated Container Preserves Power Consumption
- Exterior Stays Cool Even After Hours of Operation
- Easy to Clean Round Container
- Stainless Steel Corrosion-Resistant Interior and Exterior

The compact yet rugged design makes this alloy dispenser universally ideal for clinical use. It features polished stainless steel corrosion-resistant interior and exterior housing, a stainless steel cover and a side mounted, easy to view temperature control. Power switch, fuses and cord receptacle are mounted on the back side.

The EZ-Zone® Digital Proportional-Integral-Derivative (PID) Temperature Controller has two digital readouts, temperature and set point. It can maintain alloy at a controlled temperature up to a maximum of 250°F (121°C). The heating element provides even temperatures throughout the entire unit.

Controlling the power to the heater is done with a heavy duty Triac with Zero Crossover Switching to prevent noise from being induced into other equipment thru the AC Line.

The units are constructed with a ball valve faucet with hose barb connector for easy alloy removal. An optional 3/8" ID x 18" long (0.96 x 45.88 cm) drain tube (Item 878-158) can be attached to the faucet hose barb fitting when the dispenser is set on a shelf over the alloy blocks.

The temperature displayed is set to Fahrenheit at the factory; however, this can be changed to Celsius by the end user.

A 6' (1.8 m) AC Cord with grounded hospital grade plug is standard.

All units are single phase.

This product is not ISO certified or UL listed.

Specifications

Item	878-060	878-065
Gallons	1.5	1.5
120 VAC 50/60 Hz	X	
208/240 VAC 50/60 Hz		X
Watts	665	576/665
Amps	5.6	3.2/2.8
Alloy Capacity	120 lb (54 kg)	120 lb (54 kg)

Alloy Dispenser Temperature Range: 0° to 250°F (-18° to 121°C)

Temperature Accuracy: $\pm 4^\circ\text{F}$

Temperature Controller Type: PID

Thermocouple: J

Electronic Switching: Triac with Zero Crossover Switching

Over Temperature: 250°F Bi-Metal Disc Thermostat - Manual Reset

On/Off Switch: 10 Amp Rating

Fused: Two Line Fuses for AC Lines

Power Cord: 6' (1.8 m) 3 Wire, 10 Amp, 300 Volt, SJT, with Hospital Grade Plug

Faucet: Ball Valve with Hose Barb

878-158 Optional Drain Tubing: 3/8" ID x 18" L (0.96 x 45.72 cm)

Interior Dimension: 7 1/8" Dia. x 8 5/8" Deep (18 x 21.9 cm)

Interior Material: Stainless Steel

Exterior Dimensions: 9.75" D x 12" W x 14.5" High (25 x 30.5 x 37cm)

Exterior Material: Stainless Steel

Weight: 17.5 lbs (8 kg)

Environmental Conditions

Altitude Limits: 3000 Meters

Ambient Temperature Range: 32° - 104°F (0° - 40°C)

Relative Humidity Range: 0 to 75%

Pollution Degree: 2

FOR INDOOR USE ONLY

Item	Description
878-060	1.5 Gal, 158°/203°F, 120VAC
878-065_	1.5 Gal, 158°/203°F, 208/240V Specify Country for correct plug
878-158	Optional Drain Tubing, 3/8" ID x 18" L

FAUCET REPLACEMENTS



878-109-111



878-109-114

Item #	Description
878-109-111	Replacement Faucet for 158/203°F Alloy Dispenser, 120 VAC with 15 Watt Heater and Set Screw
878-109-114	Replacement Faucet for 158/203°F Alloy Dispenser, 240 VAC with 20 Watt Heater and Set Screw

BLOCK CASTING STATIONS

The Block Casting Station maximizes the size of your block room and can improve labor and production efficiencies while improving block quality.

FEATURES

- A 1.5 gallon alloy dispenser with a digital readout, precise digital temperature control and a no-drip heated ball valve dispenser. The alloy dispenser base plate is a roller carriage which allows for easy side-to-side movement over a range of 28" (71.37cm) over the cold plate
- A large capacity, precision surfaced refrigerated cold plate measuring 42.875" x 23.3125" (109 x 59.3cm) that accommodates up to six photon blocks. Cold water is recirculated by means of a closed loop system through a pump and refrigeration system
- The sturdy cabinet has a convenient storage space on the left side underneath the cold plate that measures 20.5" W x 23" D x 23" H (52 x 58.4 x 58.4 cm). The right side underneath cabinet houses the refrigeration system and has two (2) air vents on the side of the cabinet. These air vents need a 2" minimum clearance on the right side of the cabinet. All front and sides of the cabinet are covered with Formica brand oyster gray laminate. The back side is covered with a Formica brand phenolic resin backing sheet.
- An electronic air cleaner provides safer, cleaner air in your block room – 98% efficient at 0.03 microns.
- Power Cord: 8' (2.4m) 3 Wire, 16ga.
- Two Power Switches
 - A. Turns on electronic air cleaner
 - B. Turns on pump and compressor
- No plumbing is required

Items 878-350 and 878-351 Includes

- An electronic air cleaner provides safer, cleaner air in your block room – 98% efficient at 0.03 microns. Run at low speed.
- Power Switch to turn on electronic air cleaner

Specifications

Items 878-350 and 878-351

Overall Size: 85" H x 28" D x 43.5" W (216x71x110.5 cm)

Items 878-352 and 878-353

Overall Size: 50" H x 28" D x 43.5" W (127 x 71 x 110.5 cm)

Item	Description
878-350	Block Casting Station, 120 VAC, 85" High
878-351_	Block Casting Station, 220 VAC, 85" High Specify Country for correct plug
878-352	Block Casting Station, 120 VAC, 50" High
878-353_	Block Casting Station, 220 VAC, 50" High Specify Country for correct plug



878-350



878-352

A

BLOCK ROOM PRODUCTS & ACCESSORIES

X-400 SMOKEMASTER ELECTRONIC AIR CLEANER

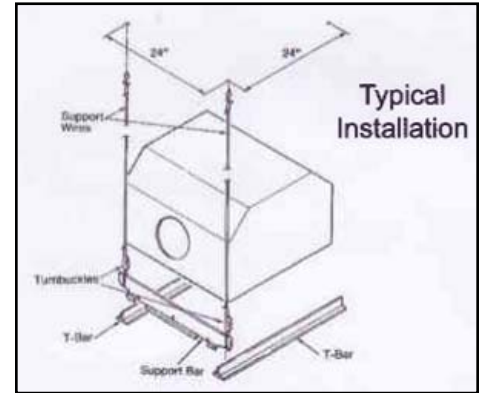
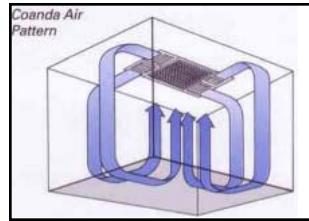
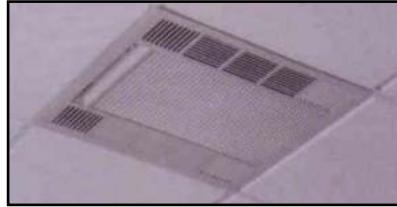

- **Totally self-contained air cleaner**
- **Ultimate 'flush with ceiling' mounted workhorse**
- **Features industrial-rated electronic filtration cell**
- **The X-400 quietly captures both airborne particles and gaseous contaminants**

The X-400 air cleaner features a high efficiency electrostatic cell designed to capture both particulate and gaseous contaminants. Contaminant particles, such as those in tobacco smoke, receive an electrical charge as they pass into the electronic cell and are then attracted to oppositely charged collector plates, where they are held, similar to the way that metal filings collect to a magnet. The air vent provides dilution control of gaseous contaminants. Standard activated carbon filter adsorbs odors and gases to further freshen the air.

The attractive grille fits flush with the ceiling and is completely inconspicuous. The cabinet is hidden in the unused space above the drop ceiling tile.

The X-400 success is due to the "Coanda Aerodynamic Principle". Effective 360° airflow gently and evenly distributes clean air and returns dirty air to the unit. The unique 4-way method of air recirculation gets the maximum amount of contaminated air to the machine most efficiently. More air reaches the Smokemaster while eliminating annoying drafts. This eliminates "stuffy" air pockets and creates people comfort as well as much better air cleaning results.

FEATURES

- **High Efficiency:** Removes dust, smoke, pollen and other particles using high efficiency electronic collector cells.
- **Quiet:** Three-speed controller is standard and allows for quiet operation without sacrificing effectiveness.
- **Easy Installation:** Special mounting brackets simplify the installation and do not require any additional space above the cabinet height of 13-5/8".
- **Economical:** Permanent electronic collector cells assure low operating cost by eliminating costly filter replacements when maintained per instructions. Moreover, because collector cells offer no airflow restriction, only limited horsepower is necessary, thus reducing noise and electrical draw.
- **Comprehensive:** Includes 2 Carbon Post Filters for odor control

Specifications

Electrical Rating: 120v / 60 Hz (220v / 50Hz)
Low Speed: 175 CFM / .4 amps (175 CFM / .45 amps)
Medium Speed: 275 CFM / .6 amps (275 CFM / .5 amps)
High Speed: 400 CFM / .8 amps (400 CFM / .7 amps)
Color: White
Motor: 0.05 Hp Thermally Protected
Dimensions: 24" x 24" x 13 5/8" (61 x 61 x 34.6 cm)
Installed Weight: 44 lb (20 kg)
Shipping Weight: 54 lb (24.5 kg)
Primary Filter Collection Area: 52.9 square feet (133 cm)
Sorbent Media: 2 Carbon Post Filters
Air Cleaning Efficiency: Up to 99.7% ASHRAE 52.2

Item	Description
878-370	X-400 Smokemaster Electronic Air Cleaner, 120 VAC
878-371	X-400 Smokemaster Electronic Air Cleaner, 220 VAC
878-375	Replacement Electronic Collector Cell
878-377	Replacement Aluminum Mesh Prefilter
878-379	Replacement Carbon Filter

A

BLOCK ROOM PRODUCTS & ACCESSORIES

MELTING ALLOY

158°F and 203°F



On average approximately 20 pounds (9.1 kg) of Melting Alloy is needed per patient.

Note: To dispose of melting alloy, place the used alloy in a container or box (Item 879-301) and send it to RPDinc. RPDinc also recycles alloy, call for details. **THIS IS HAZARDOUS AND TOXIC WASTE, DO NOT THROW IT INTO THE GARBAGE.**

Specifications

158°F Low Melting Alloy

Density: 9.38 g/cm³

Composition: Bismuth 50%, Lead 26.7%, Tin 13.3%, Cadmium 10%

203°F High Melting Alloy - Cadmium Free

Density: 9.83 g/cm³

Composition: Bismuth 52.5%, Lead 32%, Tin 15.5%

Item #	Description	Quantity
879-158	158°F Low Melting Alloy	50 lb (22.7 kg)/Pkg
879-202	203°F High Melting Alloy	50 lb (22.7 kg)/Pkg

A

GALLON BUCKETS AND BOX CARTONS FOR RETURNING USED ALLOY



To comply with Federal, State and Local Laws used alloy should be recycled or stored in sealed containers for future disposal. To properly dispose of alloy, contact your hospital hazardous waste department or your local Pollution Control Agency.

To aid in disposal, Radiation Products Design will accept all slag and used alloy.

The gallon plastic bucket has a handle for easier carrying and includes the lid. Cartons must be ordered separately to ship the buckets to Radiation Products Design for disposal.

Item #	Description
879-309	Gallon Plastic Bucket with Cover, Qty 4
879-311	Cartons for Gallon Plastic Buckets, Qty 4
879-302	Shipping Tape, 2" Wide, Clear
879-303	Tape Dispenser for 2" Wide Tape, Plastic

THERMOMETER

T-Handle, Waterproof, Drop-Proof



- Waterproof construction
- Top-reading design
- Stainless steel probe - 0.19" dia x 8" L
- Drop-proof from 5' (1.5 m)
- Large, bright, highly readable LCD display is 0.25" (6.3 mm) High
- Reading is updated every second
- With a silver-oxide battery
- Range: -58° to +536°F (-50° to + 280°C)
- Resolution: 0.1° from -20° to + 200°C; 1°C outside this range
- Accuracy: ±1°C between -20° to + 100°C
- Dimensions: 3.5" W x 9.5" H x 1" D
- Weight: 1.25 oz.

Item #	Description
878-155	Thermometer, T-Handle, Waterproof, Drop-Proof

BLOCK ROOM PRODUCTS & ACCESSORIES

SOLDERING IRON



Specifications

Power: 120 VAC, 50/60 Hz, 175 Watts
Chisel Tip: 5/8" (1.6 cm) Diameter - Included
Length: 12.5" (31.75 cm)
Weight: 1 lb (.45 kg)

Item #	Description
875-200	Soldering Iron with Chisel Tip
875-224	5/8" Replacement Chisel Tip for Soldering Iron
875-240	Stand for Soldering Iron

SOLDERING GUN Dual Heat



Specifications

Power: 120 VAC, 50/60 Hz
UL Listed

Item #	Description
875-100	Soldering Gun (260/200 Watts)
875-122	Unbent Tip End for Soldering Gun, Replacement, Pair
875-126	Pre-bent Tip w/Nuts for Soldering Gun, Replacement, Each

HEAT GUN



Specifications

Item 878-186
Power: 120 VAC, 12 Amps, 1440 Watts

Item 878-186-2
Power: 120 VAC, 14 Amps, 1680 Watts

Item #	Description	Degrees
878-186	Heat Gun	300° to 500°F
878-186-2	Heat Gun	500° to 750°F

EMERGENCY ALLOY MELTER



The Emergency Alloy Melter works on all alloy dispensers. Easy to use, just plug in and insert tip into alloy.

Specifications

Power: 110-120 VAC, 50/60 Hz, 500 watts

Item #	Description
875-250	Emergency Alloy Melter

COOLING PLATE FOR VARIAN III ELECTRON CONE INSERT FRAMES

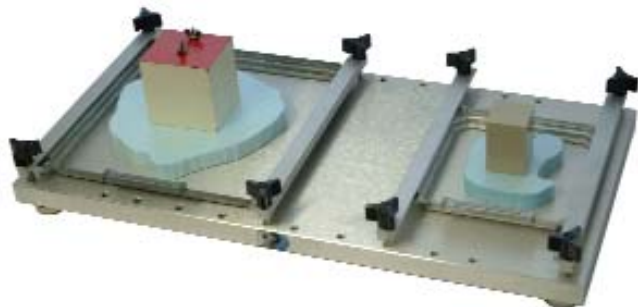

This cooling plate will accommodate up to two 25 cm electron cone frame inserts at one time. The two end bars are spring raised and need not be removed. The two center bars can be moved to fit the insert frame being used. The bars are made to fit the tri-step of the insert frame. The cooling plate sits on four leveling pads.

Specifications

Overall Size: 24" W x 12" D x 1" H (61.2 x 30.6 x 2.5 cm)
Bar Size: 0.75" W x 12" D x 1/2" H (1.9 x 30.6 x 1.3 cm)
Material: Aluminum
Knobs: Four (4) Three-Arm, 1.5" diameter (3.8 cm)

Item	Description
896-042	Cooling Plate f/Varian III Electron Cone Insert Frames

BLOCK ROOM PRODUCTS & ACCESSORIES

ALUMINUM COOLING PLATE



The Aluminum Cooling Plate aids in the cooling process of alloy blocks. It has 4 leveling feet.

Specifications

Size: 1" x 12" x 24" (2.5 x 30.6 x 61.2 cm)

Weight: 24.6 lb (11.2 kg)

Item	Description
878-270	Aluminum Cooling Plate

WATER COOLED ALUMINUM PLATES



The Water Cooled Aluminum Plate with corrosion resistance inside liner uses an external water supply to rapidly cool alloy blocks. It is anodized black for faster heat absorption. The Water Cooled Plate has a vinyl intake and discharge hose with shut off valve. The unit can be attached to a sink faucet or it can be used with our Water Transfer Tank (Item 695-000) for use in rooms without plumbing.

Specifications

Size: 1" x 12" x 24" (2.54 x 30.48 x 60.96 cm)

Fits: 3/8" (0.97 cm) Inside Diameter Hose

Weight: 28 lb (12.7 kg)

Item	Description
878-271	Water Cooled Aluminum Plate

STYROFOAM LEAD WEIGHT



The Styrofoam Lead Weight with handle is used to hold down the blocking tray when molds are being poured. Use the Aluminum Cooling Plate (Item 878-270 or 878-271) to aid in the cooling process and the Aluminum Tray (Item 878-182) to catch any excess alloy leakage. Both are pictured in use.

Specifications

Size: 2" W x 7" L x 3" H (5.1 x 17.8 x 7.6 cm)

Finish: Painted polyurethane tan

Weight: 16 lb (7.3 kg)

Item	Description
878-274	Lead Weight w/Handle for Styrofoam

STYROFOAM BLOCK COMPRESSOR

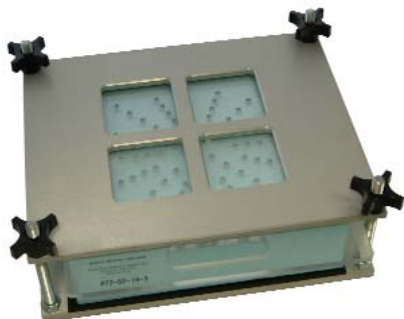

The Styrofoam Block Compressor is used to hold the styrofoam block and the treatment tray while pouring in the alloy. The block compressor will hold a maximum styrofoam block size of 12 3/4" (32.5 cm) square and a maximum treatment tray width of 12 3/4" (32.5 cm).

A 3/16" (0.5 cm) thick rubber pad is placed under the styrofoam to seal all voids when using styrofoam that does not have a planed surface. The top plate can be tightened by turning the knobs on the threaded rods.

Item	Description
878-273	Styrofoam Block Compressor

BLOCK ROOM PRODUCTS & ACCESSORIES

ALUMINUM TRAY



The Aluminum Tray is used under the Aluminum Cooling Plate (Item 878-270 and 878-271) or the Alloy Dispensers (Item 878-015 thru 878-048) to catch the alloy leakage.

Size: 25.75" L x 17.75" W x 1" D (65.4 x 45.1 x 2.54 cm)

Item	Description
878-182	Aluminum Tray

D-LEAD® HAND SOAP



876-400



876-403

D-Lead® Hand Soap quickly and efficiently removes heavy metal dusts, lead and contaminants from the skin and hands. The mild formula with skin conditioning coconut oil is designed for frequent clean up throughout the day. Fast acting and economical D-Lead® Hand Soap is the hand and skin care choice for cleanup anywhere rinse water is available.

Item	Description
876-400	D-Lead Hand Soap with Hand Pump, 8 oz
876-402	D-Lead Hand Soap Refill, 32 oz
876-403	D-Lead Hand Soap Packets, 10/Pkg

D-LEAD® ALL PURPOSE CLEANER CONCENTRATE



Multi-purpose, concentrated, low sudsing, phosphate free cleaning formula quickly lifts and suspends metals, grease, oil, dirt, paint dust and firing range residue in a single application.

Item	Description
876-405	D-Lead® All Purpose Cleaner Concentrate, 32 oz Bottle

D-WIPE TOWELS



876-450 and 876-453



876-452



876-450 and 876-454

Disposable towels are generously saturated with a gentle pH balanced cleaner to quickly remove lead and heavy metal dusts from skin and most surfaces. The soft towels lift, bind and hold lead and other heavy metal dusts and take them away without smearing. With Aloe skin moisturizers, D-Wipe towels are the portable and convenient way to clean the hands, arms, face and body.

Use D-Wipe Towels to clean

- Hands and face
- Respirators and personal protective equipment
- Desks, tables and work benches
- Telephone and keyboards
- Tools and field instruments
- Environmental and industrial health equipment
- Smooth, water washable surfaces

Item	Description
876-450	D-Wipe Towels, 6" x 6.5", 150/Pkg
876-452	Stainless Steel Wall Bracket
876-453	Plastic Wall Bracket
876-454	Locking Stainless Steel Wall Bracket

BLOCK ROOM PRODUCTS & ACCESSORIES

SCOTCH-BRITE CLEANING PADS



Specifications

Size: 3" x 4 1/2" (7.62 cm x 11.43 cm)

Item #	Description	Quantity
878-160	Scotch-Brite Cleaning Pads	10

TUBE/FAUCET CLEANING BRUSH



Item #	Description	Size
878-156	Tube Cleaning Brush	3/8" (0.96 cm) Diameter
878-157	Faucet Cleaning Brush	3/4" (1.9 cm) Diameter

ALLOY POURERS



Item #	Description
878-169	14 oz. Stainless Steel Alloy Pourer
878-170	16 oz. Plastic Alloy Pourer
878-171	33 oz. Stainless Steel Alloy Pourer

PLASTIC FUNNEL

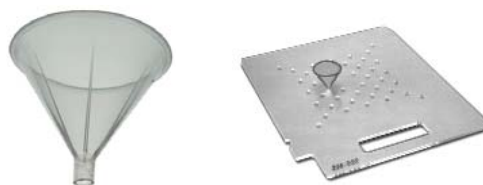

Item #	Description
878-178	Plastic Funnel

WIRE STRAINER For Low Melting Alloy



Item #	Description
878-163	Wire Strainer for Low Melting Alloy, 5" (12.7 cm) Dia.

SKIMMING SPOON



Item #	Description
878-164	Skimming Spoon

RASP



Item #	Description
878-165	Rasp, 10" (25.4 cm)

BLOCK GRIP TOOL



The Block Grip Tool is used to lower alloy blocks into the alloy melting dispenser.

Item #	Description
878-166	Block Grip Tool

BLOCK ROOM PRODUCTS & ACCESSORIES

RUBBER MALLET



Item #	Description
878-167	Rubber Mallet

UTILITY KNIFE WITH RETRACTABLE BLADE



Item #	Description
878-168	Utility Knife with Retractable Blade

POLYPROPYLENE WASTE P-TRAP For Standard 1 1/2" (3.8 cm) Plumbing



The Polypropylene Waste P-Tray can be used on sinks in the block/mold room to retain alloy that may possibly get into the drain.

Item #	Description
879-100	Polypropylene Waste P-Trap

ISLAND BLOCKING DEVICE 10" (25.4 cm)

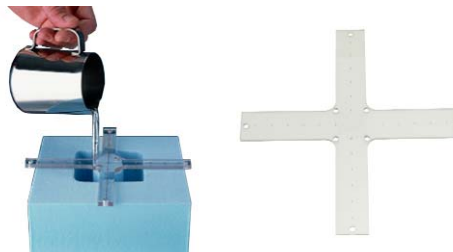

Item #	Description
878-275	Island Blocking Device, 10" (25.4 cm)

SCREWS AND WASHERS



878-2565

878-264

878-266

The stainless steel screws are used to secure the alloy blocks to the treatment trays. The nylon washers are used under the screw head to prevent the tray from cracking.

Item	Description	Quantity
878-256	S.S. Screw-Hex/Washer Head, #12 x 1"	100
878-2565	S.S. Screw-Hex/Washer Head, #12 x 1 1/2"	100
878-264	Nylon Washer for 1/4" diameter Holes	100
878-266	Nylon Washer for 3/8" diameter Holes	100

NEEDLE NOSE PLIERS With Cutter



Item	Description
878-730	Needle Nose Pliers with Cutter, 6"

CUSHION GRIP NUTDRIVER



Item	Description
878-930	Cushion Grip Nut Driver, 5/16"

A

BLOCK ROOM PRODUCTS & ACCESSORIES

STANDARD HEX KEY SETS



Specifications

Tool Type: Hex End Keys
Fastener Type: Standard Hex
Measurement Type: Inch
Handle Type: L-Key Long Arm
Hex Size Range: 1/20 - 3/8
Container Type: Plastic Holder
Number of Pieces: 13
Fractional Hex Sizes: 0.050; 1/16; 5/64; 3/32; 7/64; 1/8; 9/64; 5/32; 3/16; 7/32; 1/4; 5/16; 3/8

Item #	Description
878-757	Hex Key Set, Long Arm - 13 pc, Standard (Inch)

METRIC HEX KEY SETS



Specifications

Tool Type: Hex End Keys
Fastener Type: Standard Hex
Measurement Type: Metric
Handle Type: L-Key Long Arm
Hex Size Range: 1.5 - 10.0mm
Container Type: Plastic Holder
Number of Pieces: 9
Metric Hex Sizes: 1.5; 2; 2.5; 3; 4; 5; 6; 8; 10

Item #	Description
878-758	Hex Key Set, Long Arm - 9 pc, Metric

A

62-PIECE TOOL SET WITH TOOL BOX

This Tool Set has 62 tools and a general purpose storage box with tray.



Tool Set Contains

- (9) Hex key Fold-up Tool
- (9) Combination Wrenches 3/8", 7/16", 1/2", 9/16", 5/8", 11/16", 3/4", 13/16", 7/8"
- (9) Sockets Standard: 3/8", 7/16", 1/2", 9/16", 5/8", 11/16", 3/4", 13/16", 7/8"
- (9) Sockets Deep: 3/8", 7/16", 1/2", 9/16", 5/8", 11/16", 3/4", 13/16", 7/8"
- (1) Drive Extensions 3"
- (1) Drive Extensions 6"
- (1) Drive Universal Joint
- (1) Ratchet Handle
- (1) Adjustable Wrench 6"
- (1) Adjustable Wrench 10"
- (1) Phillips Screwdriver #1
- (1) Phillips Screwdriver #2
- (1) Slotted Screwdriver 1/4"
- (1) Slotted Screwdriver 5/16"
- (1) Slotted Screwdriver 3/8"
- (1) Pliers, Diagonal Heavy Duty
- (1) Pliers, Chain Nose with Wire Cutters
- (1) Pliers, Quick Release Locking with Curved Jaw
- (1) Pliers, Slip Joint
- (1) Pliers, Tongue & Groove
- (1) Hammer, Ball Pein
- (1) Hammer, Dead Blow
- (1) Punch, Pin 1/8"x5/16"x5"
- (1) Punch, Pin 3/16"x3/8"x5 1/4"
- (1) Punch, Drift 3/16"x1/2"x9"
- (1) Punch, Center 3/8" x 5"
- (1) Punch, Center 1/2" x 6"
- (1) Chisel, Cold 3/8"x5/16"x5 1/8"
- (1) Chisel, Cold 1/2"x7/16"x6"
- (1) Chisel, Cold 3/4"x5/8"x7"

Specifications

Storage Box: 9.5" H x 8.5" D x 20" W (24.13 x 21.59 x 50.80 cm)
Weight: 35.5 lb (16.10 kg)



Item	Description
878-745	62 Piece Tool Set with Tool Box

BLOCK ROOM PRODUCTS & ACCESSORIES

DRILL DRIVER KIT, CORDLESS, COMPACT, LITHIUM-ION, 1/2"



The DCD771C2 20V Max Lithium Ion Compact Drill/Driver Kit is lightweight and compact for working in tight spaces for long periods of time. High-speed transmission delivers 2-Speed variations allowing users to choose the level of performance needed for various applications.

Includes

(2) 20-volt Max compact Lithium ion battery packs, a compact charger and durable contractor bag

Specifications

Chuck Size: 1/2"

Chuck Type: Keyless

Clutch Settings: 16

Max Power: 300 UWO

No Load Speed: 0-450/0-1,500 rpm

No of Speed Settings: 2

System: 20V Max

Battery Type: Lithium Ion

Item Dimensions: 9.9" x 13.9" x 4.25" (25.1 x 35.3 x 10.8 cm)

Power Source: Battery-Powered

Item Weight: 3.6 lb (1.63 kg)

Item	Description
878-221	Drill Driver Kit, Cordless, Compact, Lithium-Ion, 1/2"

- Compact, lightweight design fits into tight areas
- High speed transmission delivers two speeds (0-450 & 1,500 rpm) for a range of fastening and drilling applications
- Ergonomic handle delivers comfort and control
- High performance motor delivers 300 unit watts out (UWO) of power ability completing a wide range of applications
- 1/2" single sleeve ratcheting chuck provides tight bit gripping strength

3/8" ELECTRIC DRILL

Variable Speed and Reversible



- DW223G: 7.0 Amps; 0-1200 rpm
- Helical-cut, steel gears for smooth operation
- Metal gear housing for increased durability
- Two-finger anti-slip trigger for increased comfort
- 3/8" chuck capacity for a wider range of accessories
- DIN nose for acceptability of side handle or rig mount

Specifications

Power: 120 VAC, 50/60 Hz

Item	Description
878-230	3/8" Electric Drill

A

BLOCK ROOM PRODUCTS & ACCESSORIES

HEX HEAD DRIVER SOCKET

For Drill



Item	Description
878-240	5/16" Hex Head Driver Socket

DRILL BITS

Specially Modified



These Drill Bits are specially modified for plastic, lead or cerrobend.

Item	Description
878-257	11/64" Dia. Drill Bit for Item 878-256 Screw
878-258	1/4" Dia. Drill Bit for Plastic ONLY
878-259	3/8" Dia. Drill Bit for Plastic ONLY

A

SNIPS



The Bulldog Aviation snips can be used to cut lead sheets up to 1/8" thick. This bulldog snip cuts straight and can be used in either hand. It has serrated blades.

Specifications

Nominal Length: 9" (22.9 cm)

Cut Length: 7/8" (2.22 cm)

Weight: 1 lb (0.5 kg)

Item	Description
878-738	Snips, Bulldog Aviation, 9" L



These Bulldog Blade Snips can be used to cut 1/4" thick lead sheets. This bulldog snip cuts straight and wide curves and can be used in either hand.

Specifications

Nominal Length: 16" (40.64 cm)

Cut Length: 2.5" (6.35 cm)

Weight: 3.5 lb (1.6 kg)

Item	Description
878-740	Snips, Bulldog Blade, 16" L

BLOCK ROOM PRODUCTS & ACCESSORIES

LEATHER GLOVE - UNLINED



Item #	Description
878-285	Leather Glove, Unlined - Small
878-286	Leather Glove, Unlined - Medium
878-287	Leather Glove, Unlined - Large
878-288	Leather Glove, Unlined - X-Large

LEATHER GLOVES - HEAVY DUTY



Item	Description
878-298	Leather Gloves, Heavy Duty

LEATHER APRON



The leather apron is 24" wide x 36" long with cotton ties at the neck and back.

Item	Description
878-290	Leather Apron

SAFETY GOGGLES



These anti-fog Safety Goggles with indirect venting are designed to be worn over existing glasses. One size fits all.

Item	Description
878-294	Safety Goggles

FACE SHIELD



The Headgear has a ratchet adjustment that can be tightened while wearing. The shield is attached with durable quarter turn retainers. The shield is replaceable and is unbound and clear.

Meets ANSI287.1 Standards

Item	Description
878-335	Head Gear with Face Shield
878-336	Head Gear
878-337	Face Shield

3M™ RESPIRATOR



- Meets NIOSH 42 CFR 84 N100 requirements
- 3M™ Cool Flow Exhalation Valve has patented one-way valve offering easy exhalation and cool, dry comfort
- Adjustable nose clip for custom fit and reduces the potential for eyewear fogging
- Lightweight construction with an all filter design

The 3M™ Particulate Respirator is well suited for those who want NIOSH's highest rated filtration efficiency in a maintenance free respirator. It provides a minimum filter efficiency of 99.97% against non-oil based particles. This respirator is an excellent choice for lead abatement, pharmaceutical manufacturing, welding and work involving substance specific regulated particles including lead, cadmium, and arsenic, excluding those containing oil aerosols and asbestos.

Note: This respirator contains no components made from natural rubber latex.

Item	Description
878-296	3M Dust/Mist Respirator Mask

BLOCK ROOM PRODUCTS & ACCESSORIES

AIR SAMPLING TEST KIT



Air sampling is required by OSHA safety standards. Air sampling must be conducted within an 8 hour accumulated time period. Test results will indicate the lead and cadmium levels an individual is being exposed to. If results indicate levels that exceed OSHA guidelines, action must be taken to lower the lead and/or cadmium levels within the work area and testing should be repeated. Results of all tests should be kept on file.

Item	Description
879-520-RENTAL	RENTAL UNIT Air Sampling Pump Kit
879-525	Air Sampling Filter ONLY
879-522	Testing of Sample Filter, Cadmium & Lead

A

CLEANLINE® STICKY MAT AND FRAME



Specifications

Mat Size: 18" x 36" (45.9 x 91.8 cm)

Quantity: 40 sheets to a mat

Color: White

Frame

- Provides uniform base for adhering Sticky Mats
- No maintenance required
- Enhances appearance of mats
- Pre-assembled, ready for use

The CLEANLINE® Sticky Mat Frame consist of a sloping, 3" anodized aluminum edge with a permanently secured plastic base. Overall height is 5/16".

Item	Description
877-900	CLEANLINE® Sticky Mat, 40sheets/mat
877-901	Frame for CLEANLINE® Sticky Mat

CLEANLINE® Sticky Mat

- Prevents tracking of Alloy
- Numbered corner tabs
- Smooth, effective surface
- Simple to install
- No sheet delamination
- No adhesive transfer

BLOCK ROOM PRODUCTS & ACCESSORIES

U.L.P.A. FILTERED LEAD VACUUM



877-110004



877-110005



877-384003



877-761177



877-800056

Item 877-115 U.L.P.A. Vacuum Includes

- 3 cm x 2.4 m Crush-Proof Hose
- 3 cm Telescopic Wand
- 30 cm Crevice Tool
- 8 cm Round Dust Brush
- 13 cm Uphostery Tool
- Combintion Floor Tool
- U.L.P.A Filter
- Pre-Filter Assembly for U.L.P.A. Filter, 6/pkg
- Paper Collector Bags, 10/pkg
- Polyester Filter with Wire Frame
- Protector Bags for Polyester Filter, 10/pkg

Specifications

Tank Size: 6 gallons (22 liters)

Power: 1.25 hp

Air Flow: 95 CFM

Water Lift: 2159 mm (85")

Dry Capacity: 0.46 ft³ (0.01 m³)

Cord: 50' (15.25 m)

Casters: 1.13 cm

Weight: 17 lb (8 kg)

Item	Description
877-115	U.L.P.A. Vacuum

Item	Replacement Parts
877-110004	U.L.P.A Filter, Replacement
877-110005	Pre-Filter Assembly for U.L.P.A. Filter, Replacement, 6/pkg
877-384003	Paper Collector Bags, 10/pkg
877-800056	Polyester Filter with Wire Frame
877-761177	Protector Bags for Polyester Filter, 10/pkg

- Equipped with U.L.P.A. (Ultra Low Penetration Air) filter which is 99.999% efficient at 0.12 microns
- Non-woven, embossed, polyester filter bag provides 50% more filtration area than standard bags
- State-of-the-Art polypropylene lid assembly is acousitcally designed to minimize noise to 74 dba
- Polyethylene tanks are durable, non-corrosive and dent-proof for years of reliable service
- Convenient 50' (15.25 m) cord

U.L.P.A Filtered Vacuum is used for the recovery of lead, dust, paint chips, and other hazardous materials. Conventional vacuum cleaners exhaust unseen lead particles back into the environment, compounding the existing hazard, while the U.L.P.A Filtered Vacuum collects particles directly in a disposable collection bag. The lead vacuum has been specifically designed for safe and efficient daily use in commerical and industrial sites.

MYLAR TEMPLATES

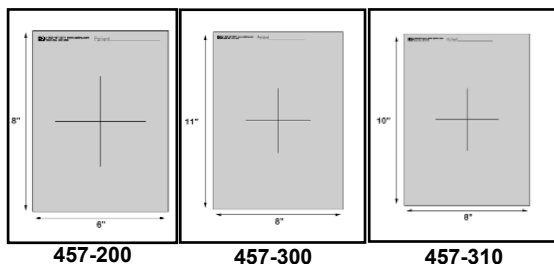

The Mylar Templates can be cleaned with Alcohol for reuse. The thickness of Items 457-200 and 457-300 has been increased to 0.010" (0.0254cm). Package Quantity: 100

Item	Mylar Template	Mark
457-200	8" x 6" x 0.010" (20.32 x 15.24 x 0.0254 cm)	+
457-300	8" x 11" x 0.010" (20.32 x 27.94 x 0.0254 cm)	+
457-310	8" x 10" x 0.005" (20.32 x 25.49 x 0.0127 cm)	+

BLOCK ROOM PRODUCTS & ACCESSORIES

CUSTOM BLOCK TRAY

All of the Block Trays are custom machined. Once Manufacturing begins, an order can not be canceled. RPDinc may request a sample tray be sent in for exact measurements with any first time tray order. Indicate the slot or hole pattern, if it is different from the sample tray. The specifications will be kept on file for any future orders.

- Choose a Tray Style and the number associated with it
- Choose scribing and the number associated with it
- Choose a pattern and the number associated with it
- Choose the material and thickness desired and the number associated with it

When you've made your choices, the item number should look like
AAA - BB - CC - D.

To build your Custom Block Tray:

Tray Styles (AAA)

All Trays Are Shown In Target View. Tray Pictures Are Not Proportionally Scaled.

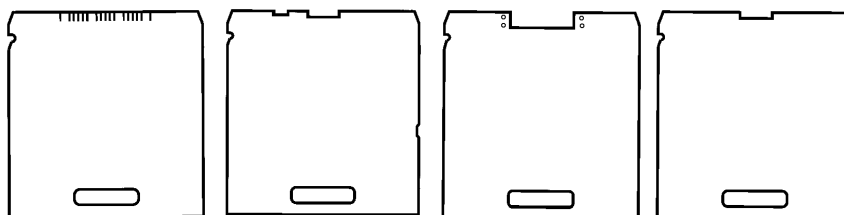

071
Siemens
Screw Coding

072
Siemens
Screw and Digital
Coding By-Pass

073
**Siemens
Digital Coding
Socket

084
Siemens
Digital Coding
By-Pass

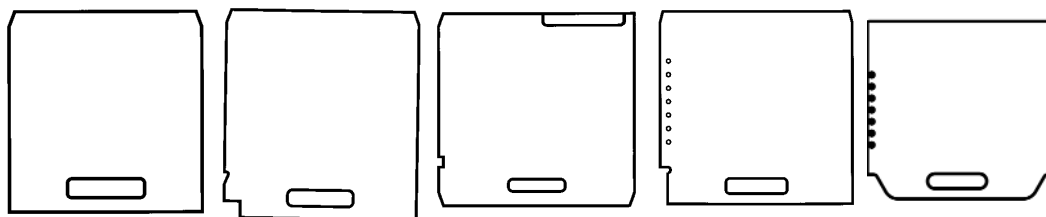

085
10" Wide
Varian CL 4

086
Varian Type II
11 3/4" Wide Tray

087
*Varian Type III
Optical Coded
No Holes

120
Elekta

122
Elekta
Synergy/Precise

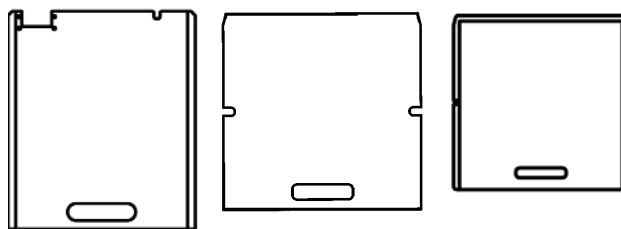

090
MDS Nordian/
Best Theratronics

160
AECL/MDSNordion/
Best Theratronics

161
Best Theratron-
Phoenix

* Coding Labels Optional

**Accepts 3 1/8" coding plugs: 1884-10-5, 1884-11-5

Scribing (BB)

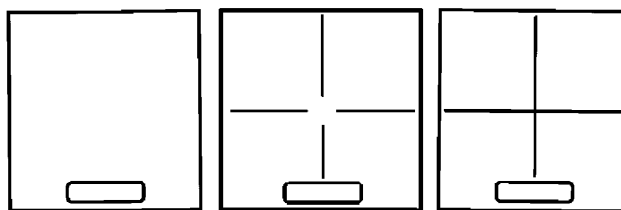

00
No Scribing

60
Open CA Scribing
Target Side

62
CA Scribing
Target Side

BLOCK ROOM PRODUCTS & ACCESSORIES

Hole and Slot Pattern (CC)

Hole Diameters available in 1/4", 3/8", or custom. Slot Widths available in 1/4", 7/32", or custom. Hole patterns available in 44 holes, 88 holes, 96 holes, or custom)

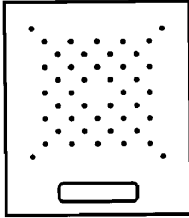

16 - 44 Holes
1/4" Dia.
17 - 44 Holes
3/8" Dia.

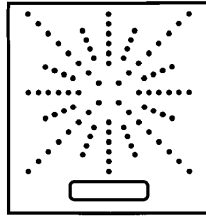

18 - 88 Holes
1/4" Dia.
19 - 88 Holes
3/8" Dia.

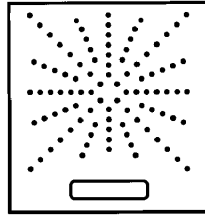

20 - 96 Holes
1/4" Dia.
21 - 96 Holes
3/8" Dia.

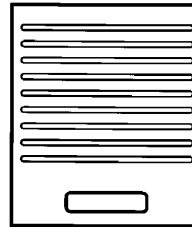

40 - 9 Slots 7/32" W
41 - 9 Slots 1/4" W

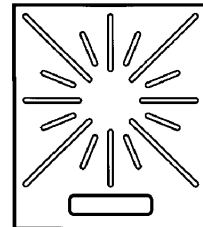

44 - 16 Slots 7/32" W
45 - 16 Slots 1/4" W

Block Tray Material and Thickness (D)

1/4" and 3/8" thick trays are most common. For very heavy blocks you may want to use 3/8" or 1/2" thick trays. Thicker trays are machined along the edges to fit the slots of the tray holder.

Acrylic

Acrylic is more rigid and scratch resistant than Lexan, however, it will break if dropped. Acrylic block trays will discolor from large amounts of radiation and may become brittle. Cracked trays should be removed from patient use, however, they could be used in the block room as set-up trays.

Acrylic Density: 1.17 to 1.20 g/cm³

Polycarbonate (Lexan)

Polycarbonate (Lexan) is virtually unbreakable, scratches easily and will flex more under a heavy load.

Polycarbonate (Lexan) Density: 1.2 g/cm³

Thickness	1/4"	3/8"	1/2"
Acrylic	1	3	5
Polycarbonate (Lexan)	2	4	6

Coding Labels and Plugs for Some Tray Styles



087-000



087-001

For Use on 087 Varian Trays ONLY

Item	Labels
087-000	Solid Black (Varian Light Blocking)
087-001	Black with Varian Coding Hole Pattern



1884-10-X



1884-11-X

For Use on 073 Siemens Trays ONLY

Plugs with threaded holes will be used on a tray that has countersunk through holes with no thread.

Plugs with countersunk holes are used on a tray that has threads in the hole.

Item	Siemens Digital Coding Plugs
1884-10-1	Threaded Mounting Holes, 3 3/8"
1884-10-5	Threaded Mounting Holes, 3 1/8"
1884-10-6	Countersunk Mounting Holes, 3 1/8"
1884-10-7	Countersunk Mounting Holes, 3 3/8"
1884-11-1	Double Coded Threaded Mounting Holes (MLC), 3 3/8"
1884-11-5	Double Coded Threaded Mounting Holes (MLC), 3 1/8"
1884-11-6	Double Coded Countersunk Mounting Holes (MLC), 3 1/8"
1884-11-7	Double Coded Countersunk Mounting Holes (MLC), 3 3/8"

A

BLOCK ROOM PRODUCTS & ACCESSORIES

TREATMENT BLOCK VERIFICATION SYSTEM with Halogen Target Lamp and View Box

A

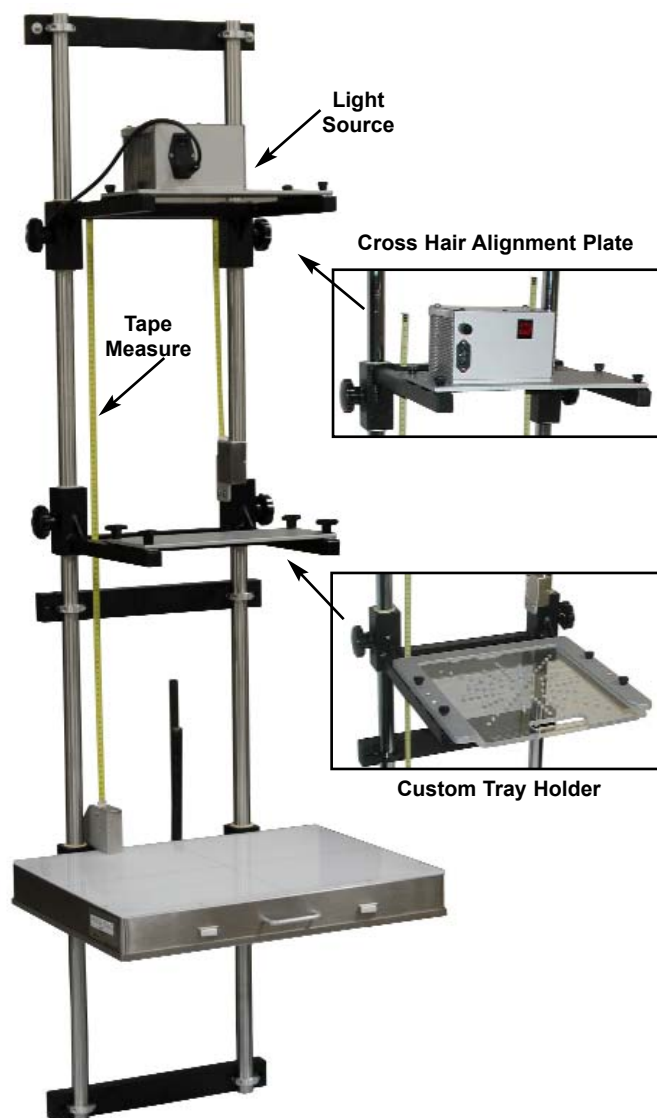

The wall mounted Treatment Block Verification System is used to verify patient treatment blocks to a port film. Due to the system's openness it gives a less confined area to work in. This adjustable system covers long target to film and target to block tray distances.

This unit uses a high intensity quartz lamp (12 volt, 50 watt) with power switch and indicator light. The Halogen lamp and power supply are mounted on a removable tray for easy replacement of the lamp. The lamp aperture hole is 2 mm in diameter and is adjustable in both the X and Y plane. A lock holds the vertical position over a 30 cm range.

The blocking tray is adjustable from 8 cm to 95 cm and has an adjustable scale that reads the target to tray distance. A vertical lock holds the tray in position. Different type treatment tray frames are available for all manufacturer's machines. This block verification unit allows inter-mixing of treatment type frames, allowing for verification of all blocks. Adjustability of each frame to central axis is mechanically done by a removable metal plate.

This high intensity view box has four 20 watt lamps with a high and low intensity switch. This allows easy viewing and alignment of the x-ray films over the crosshairs inscribed on top of the view box. The view box sits inside an adjustable metal pan which allows for easy removing and insertion, but retains alignment when re-installed. This pan is adjustable in the X and Y directions and fixed in place by locking four knobs on the bottom. A scale along the side reads target to film distance. For easier viewing of the treatment field areas, the film can be held in place with masking tape and a thin white sheet of paper can be taped down over the film. By tracing the x-ray film outline through to the white sheet of paper, visibility of the blocking area is easily seen under the high intensity light.

Both the block holding tray scale and the view box scale adjust when either the lamp tray, block tray or view box is moved.

Calibration

Central axis alignment is accomplished by using the stationary crosshair alignment plate and securing it to the block holding tray. When the target and view box are adjusted properly, the crosshairs on the blocking tray will superimpose over the view box cross-hairs and over its entire range of travel (8 cm to 95 cm). When calibration is complete, remove the crosshair alignment plate and install the block holding tray.

Specifications

Target to Block Tray Distance: 8 cm to 95 cm

Target to Film Distance: 45 cm to 195 cm

Ceiling Height: 8 ft. 2 1/2" (unit can be made shorter if requested)

Light Source

Halogen Lamp: 12 V, 50 watt

Power: 115 VAC 60 Hz or 220 VAC 3 Amp

View Box

Lamps: Four (20 watt)

Size: 18" x 24 3/4" x 2 3/4"

Power: 115 VAC 60 Hz or 220 VAC 3 Amp

Item	Description
869-400	Treatment Block Verification System, 115 VAC
869-401	Treatment Block Verification System, 220 VAC