

CT SIMULATORS, CT PRODUCTS & LASERS

CT / PET TABLE INSERT For Radiation Therapy Treatment Planning

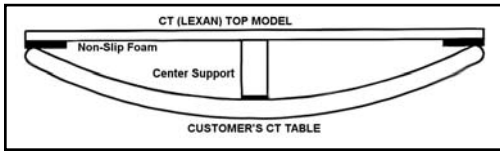

The ideal CT Image for radiation therapy treatment planning should have the patient on a flat table, magnification indicators, and density markers.

The RPDinc CT/PET Table Insert is made of 3/8" (0.97 cm) clear polycarbonate. The insert measures 84" (213.5 cm) long and the width is custom made to fit the CT or PET Table. A center support runs the length of the insert to prevent any sag.

The CT/PET Table Insert is made with foam rubber edges and will sit on top of the edges of the curved CT bed.

Optional Magnification and Density Rods

The bottom of the CT/PET Table Insert has two 1/8" (3.31 mm) diameter aluminum rods, spaced 30 cm apart that run the length of the insert and are used for magnification measurements.

A 1" (2.54 cm) diameter polystyrene rod and a 1" (2.54 cm) diameter acrylic rod are placed on either side of the center support. Both these rods run 72" (183 cm) along the bottom of the insert. These rods provide a reference for density checks.

Specifications

Table Density: Polycarbonate - 1.2 g/cm³

Rod Density: Acrylic - 1.185 g/cm³ and Polystyrene - 1.05 g/cm³

Size: 84" L x 3/8" T (213.4 x 0.97 cm)

Weight: 55 lb (25 kg)

Item #	Table Manufacturer	Magnification and Density Rods
683-310	GE	Included
683-320	Siemens	Included
683-330	Philips	Included
683-410	GE	Not Included
683-420	Siemens	Not Included
683-430	Philips	Not Included

GE LIGHTSPEED PHANTOM HOLDER FOR FLAT TABLE TOP 50 CM WIDE



The GE LightSpeed Phantom Holder attaches to a 50 cm wide flat top CT table. The GE LightSpeed Phantom Holder is an easy on, easy off unit for a flat top CT table. The bottom of the front mounting plate references the holder to the front edge of the CT table and the top is where the GE LightSpeed Phantom hooks on to the holder. A small thumb screw allows for leveling of the phantom. The two lock bars are spring loaded upward to be out of the way while securing to the CT table. The large adjustment range allows for different thicknesses of CT table tops. The phantom holder has a built-in handle for easy carrying.

Specifications

Material: Black Anodized Aluminum

Overall Size: 20.8" W x 4.5" L x 6.5" H (52.8 x 11.4 x 16.5 cm)

Mounting Plate Size: 8.45" W x 4.67" H x 0.335" T (21.5 x 11.8 x 0.8 cm)

Item	Description
018-250	GE LightSpeed Phantom Holder f/FlatTable Top 50cm W

B

CT SIMULATORS, CT PRODUCTS & LASERS

CT/MR SLESSINGER BOARD V2.0 FOR HDR BRACHYTHERAPY

- CT and/or MR Compatible
- Easy to Clean



The Slessinger Board is a padded sliding board that is CT and MR compatible. It is designed to facilitate HDR brachytherapy, specifically for pelvic treatments. The patient can be transferred onto the board from the operating room couch and remain on the board in recovery, during imaging for planning and until the HDR treatment is given. The intent is to minimize patient movement to ensure that the imaging for planning is not compromised by patient leg movement prior to treatment and thus delivering the treatment plan faithfully. The legs are slightly elevated, affording ready access to the perineum and preventing applicators from resting against anything. Leg elevation is maintained with the use of two (2) tightening knobs at the end of the elevation panels. Transfers on and off CT/MR/simulator couches are relatively easy due to the smooth plastic bottom surface and side handles. The board is also very useful when a patient is transferred via ambulance from the surgical facility to the treatment facility.

B



The CT/MR Slessinger Board V2.0 for HDR Brachytherapy has the additional benefit of having a hinged flexi-split to allow raising the head when on a stretcher. This version also includes heel cushions for additional patient comfort.



Image guided HDR brachytherapy is gaining in prominence. Prostate and gynecological applications are reliant on patient stability and comfort between the acquisition of imaging for planning and treatment. Although the Slessinger Board was devised to facilitate precise prostate HDR brachytherapy its application for image guided GYN HDR is also very significant with increasing reliance on DVH analyses. The concept of limiting rotation of a multichannel APBI balloon is yet another possible application, by avoiding the patient walking between imaging and treatment prior to each treatment fraction. The rationale and description of the Slessinger Board has also been described in the Brachytherapy Journal article by Slessinger, entitled "Practical considerations for prostate HDR brachytherapy", published early in 2010.

The Slessinger Board can be easily cleaned with non-caustic germicidal cloths or sprays. Patients may not be carried on the Slessinger Board, but rather are transferred directly from one support to another.

MR Safe

Specifications

- Base Dimensions:** 21" W x 72" L x 0.75" T (53.3 x 183 x 1.9 cm)
- Base Material:** Corrugated polypropylene
- Pad Dimensions:** 20.5" W x 69" L x 1.5" T (52.3 x 175 x 3.8 cm)
- Pad Material:** Vinyl coated closed cell foam
- Assembled Board Weight:** 26 lb (11.8 kg)
- Weight Limit:** 350 lb (159 kg)



Item	Description
946-004	CT/MR Slessinger Board V2.0 for HDR Brachytherapy

CT SIMULATORS, CT PRODUCTS & LASERS

MR/CT TITANIUM FLEX ARM FOR SLESSINGER BOARD



- MR Safe
- Cutout handle for easy placement

The MR/CT Titanium Flex Arm was designed for use in MR or CT to hold a HDR Nucletron, HDR Varian, HDR Eckert & Ziegler, FSD LDR Applicators, Vaginal Cylinder, Tandems or other objects securely in place during GYN brachytherapy treatment on the Slessinger Board.

The MR/CT Titanium Flex Board (Blue) is mounted to the Slessinger Board with a knob and washers and can be moved in or out of the patient approximately 5". The treatment applicator is placed into the patient while laying on the Slessinger Board. The Flex Arm rail block is slid onto the board rail and the applicator clamp is adjusted to fit onto the treatment applicator and locked. The Flex Arm rail block is then locked into place.

The vertical post allows the Flex Arm to rotate 360° and has vertical markings every half centimeter from 3 cm to 15 cm. The wing knob on the vertical post clamp locks the elevation, rotational and in/out position of the Flex Arm. Slightly tightening the wing knob will lock the vertical post clamp in rotation and elevation.

Further tightening will lock the in/out travel of the Flex Arm. The wing knob at the end of the Flex Arm locks the swivel of the applicator clamp. Loosen the Flex Arm wing knob to adjust the swivel of the applicator clamp into position and attach to the treatment applicator. When attached to the treatment applicator, tighten the Flex Arm wing knob at the end of the Flex Arm. Then tighten the post wing knob to lock in/out position of the Flex Arm.

The applicator clamp end of the Flex Arm has a cutout swivel that houses a ball stud and allows the applicator clamp 360° of rotation. A thumb screw will lock the clamp and another thumb screw locks the board rail block.

Specifications

Base Size: 5.5" W x 16" L x 0.25" thick (13.8 x 40.64 x 0.6cm)

Handle Cutout: 4" W x 1" L (10.1 x 2.5cm)

Material: HDPE Blue Polyethylene Colorboard

Flex Arm Size

Arm Height: 16.2cm

Flex Arm Material: Titanium

Vertical Post Material: Black Aluminum

Item #	MR/CT Ti Flex Arm for Slessinger Board
946-0531	with Nucletron
946-0532	with Varian
946-0533	with Eckert & Ziegler
946-0534	with FSD / Weeks

ARTICULATING SS ARM SLESSINGER BOARD

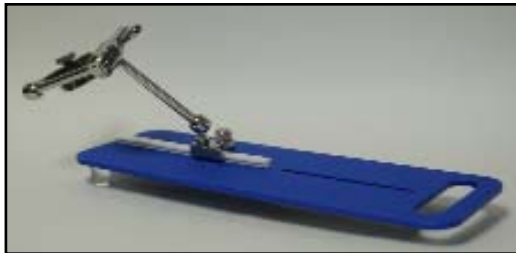

- Cutout handle for easy placement

The Articulating Arm Board was designed to hold a HDR Nucletron, HDR Varian, HDR Eckert & Ziegler, FSD LDR Applicators, Vaginal Cylinder, Tandems or other objects securely in place during GYN brachytherapy treatment on the Slessinger Board.

The Articulating Stainless Steel Arm Board (Blue) is mounted to the Slessinger Board with a knob and washers and can be moved in or out of the patient approximately 5". The treatment applicator is then placed into the patient while laying on the Slessinger Board. The Articulating Arm rail block is slid onto the board rail and the applicator clamp is adjusted to fit onto the treatment applicator and locked. The Articulating Arm and rail block is then locked in place.

The applicator clamp is fixed to one arm of the articulating arm and the other arm is fixed to the rail block. The rail block slides onto the 6" long board rail and is locked in position with the thumb screw.

The Articulating Arm has two (2) arms that can rotate 360°. The end of each arm has a cutout swivel that houses a ball stud and allows for another 360° of rotation. A wing knob in the center of the arms locks the position of both arms and the swivel ball ends.

Specifications

Base Size: 5.5" W x 16" L x 0.25" thick (13.8 x 40.64 x 0.6cm)

Handle Cutout: 4" W x 1" L (10.1 x 2.5cm)

Material: HDPE Blue Polyethylene Colorboard

Item #	Articulating SS Arm Slessinger Board
946-0631	for Nucletron
946-0632	for Varian
946-0633	for Eckert & Ziegler
946-0634	for FSD / Weeks

CT SIMULATORS, CT PRODUCTS & LASERS

VISIONMARK™ CT



The VisionMark™ CT markers offer the perfect combination of tack surfaces and easy-peel corners, keeping the markers correctly positioned with minimal discomfort to the patient on removal. These **NON-METALLIC** markers reduce read time on CT scans with virtually no scatter. These sizes and ball densities are perfect for all CT skin marking applications. Available in 3 mm, 4 mm, and 5 mm ball sizes. No lead means they are safer for yourself, your patient and the environment.

CT Mark Wire and Dots



The CT Mark wire and dots are a new blue formation designed specifically for CT. These markers are lead free, will not cause artifact (scatter) on CT scans and the labels are latex-free.

Item	Visionmark™ CT	Quantity
680-305	2.0 mm Ball	50
680-310	2.5 mm Ball	50
680-312	3.0 mm Ball	50
680-314	4.0 mm Ball	50
680-316	5.0 mm Ball	50

Item	Description	Quantity
680-349	CT Mark Wire, 1.0 mm	330 cm
680-350	CT Mark Wire, 2.0 mm	300 cm
680-352	CT Mark, 2.3 mm	110
680-354	CT Mark, 4.0 mm	50

CT MARKER-INDICATOR RADIOPAQUE

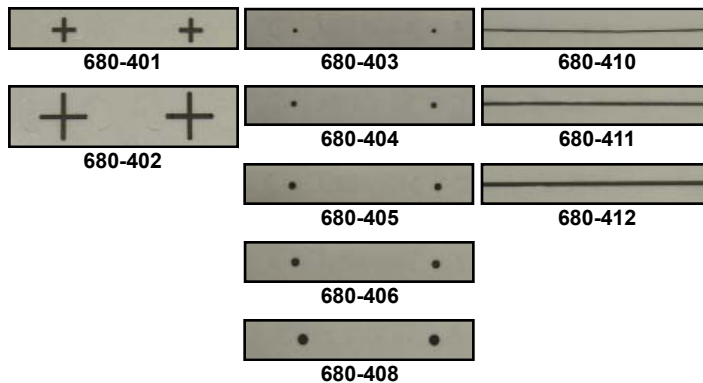

- Use in CT, RT Simulation, Treatment Planning, Diagnostic Radiology, Angiography, Mammography and Fluoroscopy
- Use to identify masses, scar tissue, moles, birth marks or any point of interest
- Provides a clear and accurate reference point with no spray artifacts
- Flat marker - will not indent tissue
- Disposable
- Clear adhesive backing
- Multiple sizes available
- Lead Free
- Crosses - 0.38" L (9.5 mm)
- Dots - 0.125" diameter (3 mm)
- Lines - cut to desired length
- NOT for use in MRI

Item #	CT Marker-Indicator Radiopaque	Quantity
680-401	Crosses, 10 mm	130
680-402	Crosses, 20 mm	130
680-403	Dots, 1.5 mm	115
680-404	Dots, 2.0 mm	115
680-405	Dots, 2.5 mm	115

Item #	CT Marker-Indicator Radiopaque	Quantity
680-406	Dots, 3.0 mm	115
680-408	Dots, 4.0 mm	115
680-410	Line, 0.5 mm	69" (175 cm)
680-411	Line, 1.0 mm	66" (167 cm)
680-412	Line, 1.50 mm	62.5" (159 cm)

CT SIMULATORS, CT PRODUCTS & LASERS

X-LINE™ PRECISION RADIOTHERAPY TAPE FOR CT SIMULATION



X-Line™ allows accurate contouring within distorted regions of the CT image, improving radiotherapy outcomes.

Obese patients must be imaged with the extended field of view (eFOV), often resulting in distorted body contours. X-Line™ provides a series of reliable dots within the distorted sections of the eFOV, allowing for easy identification of the true body contour. The radiopaque lines on X-Line™ show up as hyperdense lines in CT simulation. Connect underneath the dots to get an accurate body contour - it's that easy!

Body contour distortion from large patients in the eFOV

- GE Discovery CT590 RT, Optima CT580 RT and LightSpeed RT have a scan FOV (sFOV) of 50cm and a 65cm extended FOV (eFOV) option
- Siemens Somatom models have a 50cm sFOV and eFOV up to 80cm
- Body regions within the eFOV is distorted and contains artifact, resulting in an inaccurate body contour
- Body contour inaccuracies can lead to incorrect SSD and dosage calculations

X-Line™ General Instructions

- Apply X-Line™ to all body regions that might fall outside of the scan field of view
- Tear a strip length that fully encompasses the region of interest
- Expect to use 3-5 strips per patient, depending on their size

Step 1 - Peel

- Peel away the protective backing
- X-Line™ is kiss cut to make for easier removal

Step 2 - Apply

- Apply X-Line™ to the region of interest
- Orient the radiopaque lines perpendicular to the direction of the CT cross section
- Space the X-line™ strips approximately 1 inch apart
- Only apply each X-Line™ strip once

Step 3 - Scan

- Then, perform the CT scan as usual
- Remove and discard the X-Line™ strips after the scan

Step 4 - Connect

- Finally, connect just underneath the bright, hyperdense dots in the resulting CT images
- Connecting underneath the dots avoids including these hyperdense regions in the radiation dose planning

Specifications

Size: 2" wide (5.08 cm) with three equally spaced radiopaque lines 1" apart (2.54 cm)

Quantity: Rolls are 50' long (15.24 m) with perforations spaced every 2" (5.08 cm).

Item	Description
680-470	X-Line Tape, Full Adhesive
680-475	X-Line Tape, Partial Adhesive

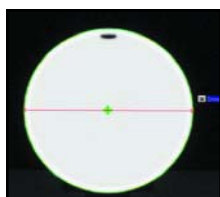

Clear scan within sFOV

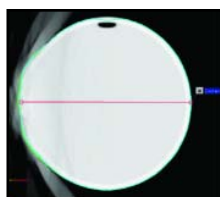

Distorted image in 65cm eFOV

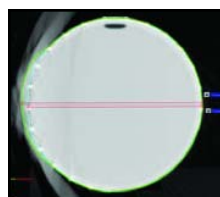

X-Line™ connect-the-dots body contour

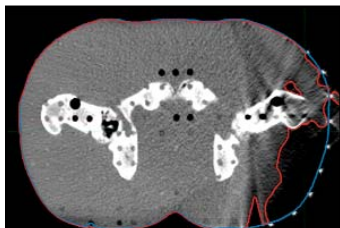

Siemens HDFOV PRO Phantom

A Solution to CT Simulation Image Distortion in Obese Patients

- More Accurate
- Fast and Simple
- Low-Cost
- Optimal Dosage
- Latex Free

B

CT SIMULATORS, CT PRODUCTS & LASERS

MULTI-MODALITY MARKERS



Item 462-029 Multi-Modality Markers for Radiology/Radiation Therapy

- Appears as bright object on CT, MRI and Diagnostic Imaging scans
- Inner center hole affords passage of needle through central hole
- 15 mm outer diameter and 3.5 mm thick
- 5 mm axial hole with 2 mm central hole
- Composed from hydrogel with medical grade adhesive

Item 462-030 Multi-Modality Markers for Nuc Med/PET

- Visible on Nuclear Medicine, CT and MRI scans
- Liquid-containing well suitable for injection of short-life radionuclide using a conventional hypodermic needle
- 15 mm outer diameter and 3.5 mm thick
- 5 mm axial hole
- Composed from hydrogel with medical grade adhesive

Item #	Description	Quantity
462-029	Multi-Modality Markers for Radiology/Radiation Therapy	50
462-030	Multi-Modality Markers for Nuc Med/PET	50

CT MARKER

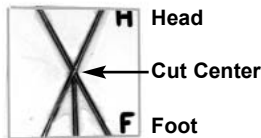

Material: Aluminum Wire
Size: 1" (2.54 cm) Square

Item #	Description
680-125	CT Marker

MULTIMODAL SPOT MARKERS

Written Verification of Radioactive Materials License is Required to Place an Order



The Multimodal Spot Markers are used for patient orientation and image registration in camera studies. The Co-57 is used for CT-SPECT and Ge-68 and Na-22 for CT-PET fusion imaging.

Specifications

Model MMS02

Capsule: 1" dia. x 1/4" (2.54 x 0.64 cm) thick clear cast acrylic

Active Dimensions: 1.5 x 1.5 mm cylinder

CT Target: 1/4" (0.64 cm) OD bone-equivalent ring (surrounds active element)

Suggested Usage: Multimodal fiducial marker for image coregistration

Model MMS03

Capsule: 1" dia. x 1/4" (2.54 x 0.64 cm) thick clear cast acrylic with etched "crosshairs" centered on active element for laser alignment

Active Dimensions: 1 mm diameter sphere

CT Target: 2 mm OD bone-equivalent ring (surrounds active element)

Suggested Usage: Multimodal fiducial marker for image coregistration

Model	Nuclide	10 μ Ci .37 MBq	25 μ Ci .925 MBq	50 μ Ci 1.85 MBq	100 μ Ci 3.7 MBq
MMS02	Co-57	680-200	680-201	680-202	680-203
MMS02	Ge-68	680-210	680-211	680-212	680-213
MMS02	Na-22	680-220	680-221	680-222	680-223
MMS03	Co-57	680-230	680-231	680-232	680-233
MMS03	Ge-68	680-240	680-241	680-242	680-243
MMS03	Na-22	680-250	680-251	680-252	680-253

CT SIMULATORS, CT PRODUCTS & LASERS

CT MARKING WIRE



Item	China Markers	Length
682-080	Aluminum Wire 0.080" (2.03 mm) Diameter	42' (12.8 m)
682-090	Aluminum Wire 0.040" (1.02 mm) Diameter	165' (50.3 m)
682-100	Aluminum Wire 0.064" (1.63 mm) Diameter	67' (20.4 m)

CT RECTAL MARKER

Rectal - Vaginal - External



The Rectal Marker can be used as a vaginal marker or an external marker.

Specifications

Sterilization: Gas

Tubing: 5/16" (8 mm) Dia. x 30 cm Flexible

Balls: 3/16" (5 mm) Dia. Spaced Every cm

Anus Locator: Adjustable Delrin

Latex Cover: 2.0 cm Dia. x 30 cm L

The **NON-METALLIC** CT Rectal Marker is a flexible tube packed with teflon balls spaced at 1 cm intervals from center to center.

The Rectal Marker is used to accurately obtain both the rectum position and magnification by counting the balls. This determines the rectum location relative to the radiation field.

An adjustable anus marker can be utilized during CT simulation.

Item #	Description
460-010	CT Rectal Marker with Anus Marker
460-006-12	Latex Cover for Rectal Marker, 12/pkg
460-006-24	Latex Covers for Rectal Marker, 24/pkg

SHADOWFORM MARKERS



- T-Bar handle which can be removed for insertion of barium
- Disposable
- Rectal markers are available in two lengths and are marked at 1 cm intervals
- No cross contamination
- Outlines the soft tissue of the pelvic region
- Latex-free
- Markers are made from a soft, smooth, flexible plastic
- Used for Simulation and CT Planning
- Provides excellent localization of pelvic structures

CE

Item	Shadowform Markers	Quantity
460-501	18 cm Vaginal Marker	10
460-502	38 cm Rectal Marker	10
460-503	10 cm Rectal Marker	10

CT SIMULATORS, CT PRODUCTS & LASERS

CT VAGINAL DEPTH SCALE



The **NON-METALLIC** CT Vaginal Depth Scale is 1.6 cm in diameter and 26 cm long and has teflon balls which are spaced 1 cm apart and are 5 mm diameter. A delrin introitus marker is included with the 1.6 cm diameter vaginal scale (Item 707-145). A thumb screw holds the introitus marker in position.

The Vaginal Depth Scale Holder (Item 707-020) can be used in CT if the area to be scanned does not include the holder.

Specifications

Material: Acrylic
Density: 1.1859 g/cm³

Material: Teflon
Density: 2.16 g/cm³

Item #	Description
707-145	CT Vaginal Depth Scale with Introitus Marker
707-020	Vaginal Depth Scale Holder
460-006-12	Latex Cover for Vaginal Depth Scale, 12/pkg
460-006-24	Latex Covers for Vaginal Depth Scale, 24/pkg

B

CT/MR VAGINAL DILATORS AND HOLDER WITH ADJUSTABLE HEIGHT AND ANGLE

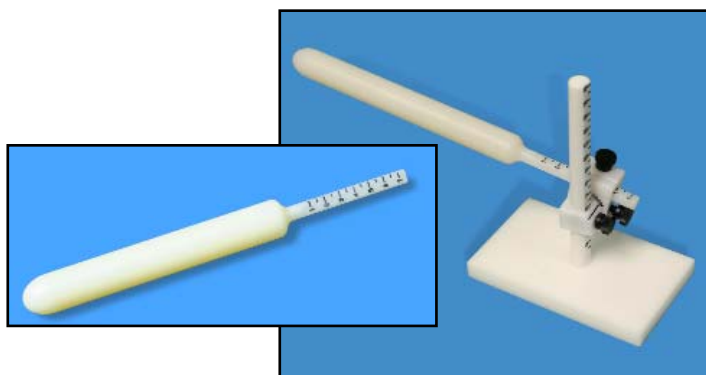

The base can be set into position in the vacuum cushion that is used for positioning the patient legs. This will give a reproducible base location on a daily basis.

Specifications

Item 946-200
Base Size: 3" x 5" x 0.5" Thick (7.6 x 12.7 x 1.27 cm)
Vertical Post Scale: From 2.5 cm to 15 cm with black markings every 5 mm and whole numbers every centimeter starting at 3.0 cm
Angle Scale: Marked every 5° to 45°
Material: Ertalyte
Clamp: Dual clamps with thumb screws allow for vertical and anterior-posterior angle adjustment of the dilator
CT/MRI Safe
Sterilization: Autoclave or gas

The CT/MR Vaginal Dilators and Holder were designed to be used when treating anal cancer in females with chemoradiation. The use of a dilator is used to delineate and displace the vulva and lower vagina away from the primary tumor with the intention of decreasing dose to these areas.

The vertical post scale on the holder allows for reproducing from day to day the vertical position of the dilator. The dilator can also be angled up or down in the anterior - posterior position with a scale marked every 5° to 45° and a locking thumb screw. The optional dilators have a scale on the shaft that ranges from 1cm to 7cm which is used for depth.

The base can be set into position in the vacuum cushion that is used for positioning the patient legs. This will give a reproducible base location on a daily basis.

Items 946-220 to 946-235

Material: Nylon
Overall Length: 10" (25.4 cm)
Dilator Length: 6.5" (16.5 cm)
CT/MRI Safe

Item #	Description
946-200	Vaginal Dilator Holder, CT/MR - Adj. Height & Angle
946-220	20mm Dia. Rounded Nylon Dilator with Scaled Shaft
946-225	25mm Dia. Rounded Nylon Dilator with Scaled Shaft
946-230	30mm Dia. Rounded Nylon Dilator with Scaled Shaft
946-235	35mm Dia. Rounded Nylon Dilator with Scaled Shaft

FLUKE CT ION CHAMBER, 10 cc



Electrode Material: Aluminum, 1100
Sensitivity: 3.2 R·cm/nC (nominal) or 0.3/nC
Standard Calibration: 100 kVCP, 5.5 mm Al HVL (NIST Tech. M100)
Response Uniformity Along Axis: ± 3% over central 90% of active length
Beam Orientation: Normal to chamber axis
Leakage Current: (300 V collection potential) Less than 10^{-14} A at 10 min polarization time
Intensity Limits: Continuous beam: 31.6 R/Sec, (1% recombination loss)
Pulsed Beam: 15.8 mR/pulse (1% recombination loss)
Collection Time: 0.478 mSec
Cable Length: 3' (0.9 m)
Operating Voltage: -300 V

Specifications

Detector Type: Vented air ion chamber
Volume: 10.1 cc
Sensitive Length: 10.0 cm
Chamber Material: Acrylic (PMMA)
Chamber Outside Diameter: 0.5 in ± 0.015 in (12.7 mm ± 0.4 mm)
Chamber Inside Diameter: 0.45 in (11.44 mm)
Chamber Wall Thickness: 77 mg/cm²

Item #	Description
300-510	CT Ion Chamber High Sensitivity, 10 cc for multislice CT, with triax BNC: used with the 35040 ATD and other electrometer/dosimeters, including TRIAD™ and TRIAD™ TnT

B

EXRADIN A17 SLICE THERAPY CT CHAMBER

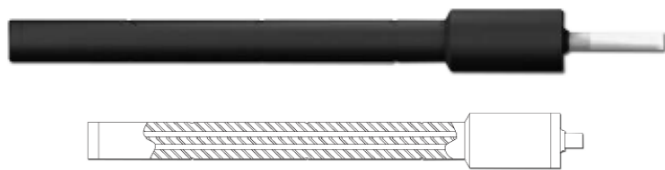

Exradin A17 Schematic

- Fiducial markers identify center and both ends of the collecting volume providing easy setup in relation to the beam
- Proven guard design yields stable, precise measurements and minimizes settling time by creating uniform field lines
- Shell and guard are made of durable, long lasting Shonka conductive plastic
- Use of homogeneous material throughout the chamber minimizes perturbation of the beam due to the presence of the chamber and optimizes measurements
- Axially symmetric design of the chamber provides an uniform, isotropic response
- Inherent waterproof construction eliminates need for additional protective coverings
- The Model A17 Exradin Slice Therapy Chamber has an inherent ⁶⁰Co buildup cap built into its wall thickness for air calibrations and measurements
- Ionization collection efficiency is 99.9% or better
- Collecting volume is 1.91 cc

CT ion chambers combine robust design with uniform energy response for high energy MV applications.

For performing measurements necessary for calculating CTDI (CT dose index)

The Model A17 Exradin Slice Therapy Chamber is designed for tomotherapy applications. This chamber is useful for weekly QA checks or patient dose verification with phantoms or water tank setups. It has excellent response uniformity over the central 8 cm of the chamber length, with variation less than plus or minus 1.5%.

Fast, Precise Measurements

Its waterproof construction makes it ideal for checking the consistency of beams at various jaw widths. The chamber vents through a flexible tube that surrounds the triaxial cable, ensuring the collecting volume is in pressure equilibrium with the surroundings. The design assures there are no stem or voltage soakage effects, providing precise and reliable measurements.

Durable Construction, Built to Last

The Model A17 Exradin Slice Therapy Chamber is constructed of rugged C552 Shonka air-equivalent plastic, providing excellent conductivity and years of reliable use.

Specifications

- Collecting Volume:** 1.91 cm³
- Collecting Volume Length:** 8.0 cm
- Collector Diameter:** 2.4 mm
- Body Tube Outside Diameter:** 12.7 mm
- Wall Thickness:** 3.3 mm
- Chamber Length:** 17.0 cm
- Body Tube and Guard Material:** Shonka air-equivalent plastic C552
- Response Uniformity Over the Central 8.0cm of Chamber Length:** ±1.5%
- Collector Material:** Carbon fiber
- Electrical Power Requirements:** Operates at ±300 VDC
- Nominal Collection Efficiency:** 100%
- Maximum Polarizing Potential:** 1000 V
- Nominal Inherent Leakage Currents:** 10⁻¹⁵ A
- Low-Noise Triaxial Cable:** 50 ohms, 29 pF/ft, 1.5 m long
- Signal Connector:** Triaxial BNC plug (2-Lug, male pin); others available upon request
- Waterproof:** Yes
- Product Standards:** CE₀₄₁₃, Designed to meet IEC 60601-1, IEC 61674



Item	Description
300-540	CT Chamber, Exradin A17 Slice Therapy

EXRADIN A101 CT CHAMBER



Exradin A101 Schematic

- Fiducial markers identify center and both ends of the collecting volume providing easy setup in relation to the beam
- Proven guard design yields stable, precise measurements and minimizes settling time by creating uniform field lines
- Shell and guard are made of durable, long lasting Shonka conductive plastic
- Use of homogeneous material throughout the chamber minimizes perturbation of the beam due to the presence of the chamber and optimizes measurements
- Axially symmetric design of the chamber provides an uniform, isotropic response
- Ionization collection efficiency is 99.9% or better
- Collecting volume is 4.54 cc

Uncompromising Quality

CT ion chambers combine robust design with uniform energy response for low energy kVCT applications.

For Performing Measurements Necessary For Calculating CTDI (CT Dose Index)

The Exradin Model A101 CT Ion Chamber is designed to perform the measurements necessary for calculating the CTDI (computed tomography dose index) as described in the AAPM TG 74, Quality Control in Diagnostic Radiology. The chamber is 10 mm in diameter and comes with an acrylic sheath for use with phantoms that have the typical 13.1 mm cavity. It has excellent response uniformity over the central 10 cm of the chamber length, with variation less than plus or minus 3%.

Fast, Precise Measurements

Model A101 is ideal for checking the consistency of beams at various jaw widths. The chamber is vented to the ambient, ensuring the collecting volume is in pressure equilibrium with the surroundings. The design assures there are no stem or voltage soakage effects, providing precise and reliable measurements.

Durable Construction, Built to Last

The Model A101 CT Chamber is constructed of rugged C552 Shonka air-equivalent plastic, providing excellent conductivity and years of reliable use.

Specifications

Collecting Volume: 4.54 cm³

Collecting Volume Length: 10.0 cm

Collector Diameter: 2.4 mm

Body Tube Outside Diameter: 10.0 mm

Wall Thickness: 1.0 mm

Chamber Length: 164.3 mm

Body Tube and Guard Material: Shonka air-equivalent plastic C552

Response Uniformity Over the Central 10 cm of Chamber Length: ±3%

Energy Response: 80 kVp to 150 kVp ±4%

Collector Material: Carbon fiber

Electrical Power Requirements: Operates at ±300 VDC

Nominal Collection Efficiency: 100%

Maximum Polarizing Potential: 1000 V

Nominal Inherent Leakage Currents: 10⁻¹⁵ A

Low-Noise Triaxial Cable: 50 ohms, 29 pF/ft, 1.5 m long

Included Adapter Sleeve: Wall thickness of 1.3 mm; constructed of PMMA

Signal Connector: Triaxial BNC plug (2-Lug, male pin); others available upon request

Waterproof: No

Product Standards: CE₀₄₁₃, Designed to meet IEC 60601-1, IEC 61674

CE

Item #	Description
300-550	Exradin A101 CT Chamber

B

CT SIMULATORS, CT PRODUCTS & LASERS

PTW CT CHAMBERS

PTW 30009 CT CHAMBER



Vented cylindrical pencil chamber for dose length product measurements in computed tomography

- Pencil type chamber for measurements within a CT head or body phantom or free in air
- Provides a sensitive measuring length of 10 cm
- Shows a homogeneous response over the whole chamber length

The CT chamber is a vented cylinder chamber designed for dose length product and dose length product rate measurements in computed tomography. The chamber allows the determination of the $CTDI_{100}^1$, $CTDI_W^2$ and $CTDI_{Vol}^3$ according to IEC 61223-2-6 and IEC 61223-3-5.

¹ $CTDI_{100}$ = Computed Tomography Dose Index 100

² $CTDI_W$ = Weighted $CTDI_{100}$

³ $CTDI_{Vol}$ = Volume $CTDI_W$

Item	Description
300-560	PTW 30009 CT Chamber, 3.14 cc

PTW 30017 CT CHAMBER



Vented cylindrical pencil chamber for dose length product measurements in computed tomography

- Pencil type chamber for measurements free in air
- Provides a sensitive measuring length of 30 cm
- Shows a homogeneous response over the whole chamber length

The CT chamber is a vented cylinder chamber designed for dose length product and dose length product rate measurements in computed tomography according to the amendment to IEC 60601-2-44.

Item	Description
300-565	PTW 30017 CT Chamber, 9.3 cc

Specifications	Item 300-560	Item 300-565
PTW Model	30009	30017
Type of Product	Vented pencil type chamber	
Application	Dosimetry in computed tomography	
Measuring Quantity	Air kerma length product, exposure length product	
Reference Radiation Quality	120 kV, HVL 8.4 mm Al (RQT9)	
Nominal Sensitive Volume	3.14 cm ³	9.3 cm ³
Design	Not waterproof, vented, pencil type	
Reference Point	Chamber center	
Direction of Incidence	Radial	
Nominal Response	14 nC/(Gycm)	13 nC/(Gycm)
Chamber Voltage	-100 V nominal ± 500 V maximal high voltage to be connected only with active current-limiting device ($I_{max} < 0.5$ mA)	
Energy Response	≤ ±5% for 70 - 150 kV	≤ ±5% for 50 - 150 kV
Leakage Current	≤ ±10 fA	
Cable Leakage	≤ 1pC/(Gycm)	
Materials and Measures		
Wall Material	1 mm PMMA, graphite coated	
Wall Area Density	119 mg/cm ²	
Dimension of Sensitive Volume	Radius 3.5 mm Length 100 mm	Radius 3.5 mm Length 300 mm
Wall Area Density	119 mg/cm ²	
Electrode	Al tube, graphited outer diameter 3 mm	
Ion Collection Efficiency at Nominal Voltage		
Ion Collection Time	274 μs	
Max. Dose Rate for ≥95.0% saturation	12.4 Gy/s	
Max. Dose Per Pulse for ≥95.0% saturation	2.26 mGy	
Useful Ranges		
Chamber Voltage	± 100 - 400 V	
Radiation Quality	50 - 150 kV electrons	
Temperature	10° to 40° C, 50° to 104° F	
Humidity	10 to 80%, max 20 g/m ³	
Air Pressure	700 - 1060 hPa	

CT SIMULATORS, CT PRODUCTS & LASERS

CT DOSE PHANTOM

Acrylic

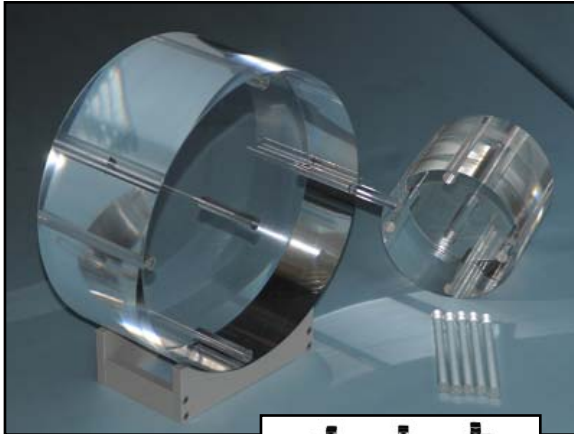

- Usable on all CT scanners
- Head and abdominal configurations included
- Made from acrylic with a density of 1.19 gm/cc
- Includes 10 PMMA plugs
- 1.31 cm inside hole dia. sized for standard CT Dose probes
- Rugged foam lined carrying case included

The CT Dose Phantom consists of two 15 cm thick Solid PMMA disks measuring 16 cm (head) and 32 cm (body) in diameter.

The disks have five through-holes with an inside diameter of 1.31 cm to accommodate standard CT dose probes and five acrylic rods to plug the holes not in use. One hole is at center and four are around the perimeter, 90° apart and 1 cm from hole center to the outside edge of the phantom.

The head and body phantoms along with the ten acrylic rod plugs are packaged in an extremely rugged foam lined carrying case.

Item	Description
682-005	CT Dose Phantom, Acrylic

B

CT SIMULATORS, CT PRODUCTS & LASERS

CT DOSE INDEX PHANTOM

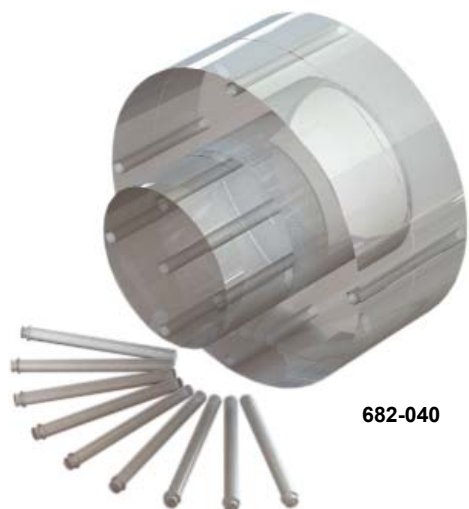

682-040

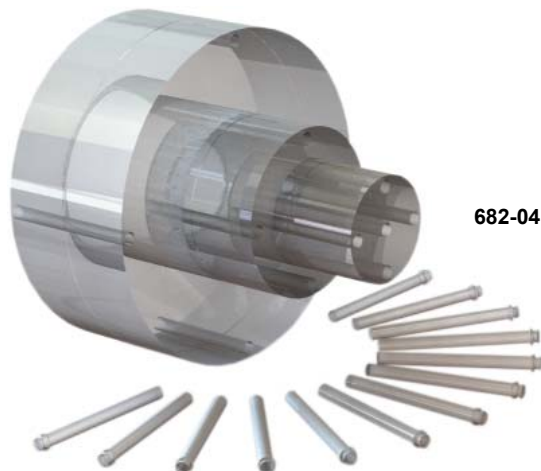

682-045

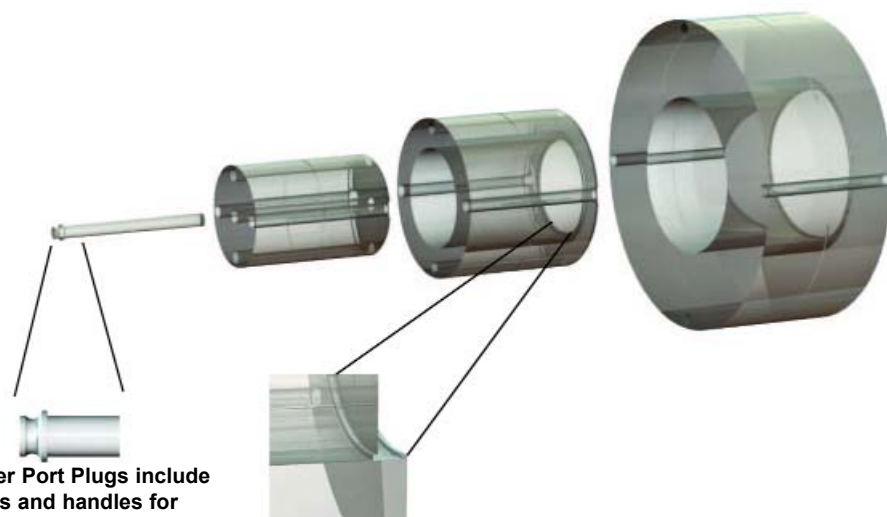

Chamber Port Plugs include stops and handles for precise positioning

Tongue and groove design provides fast setup times and ensures precise module alignment



Each module allows the user to collect dose measurements on the central axis of the phantom or at periphery positions located every 90 degrees at 1.0-cm depth from the surface.

Includes customized, water-tight hard case for easy transport & safe storage. Case includes built-in wedges for use as a phantom holder.

Specifications

Material: Polymethyl-Methacrylate (PMMA/Acrylic)

Density: 1.19 g/cm²

Alignment Markings: Etched lines centered at the transverse, coronal and sagittal planes

Chamber Ports Diameter: 1.31 cm

Dimensions

Adult Body: 32 cm x 14.5 cm

Adult Head/Pediatric Body: 16 cm x 14.5 cm

Pediatric Head (Item 682-045 only): 10 cm x 14.5 cm

Item #	Description
682-040	CTDI Phantom - Adult, 2 -Piece
682-045	CTDI Phantom -Adult & Pediatric, 3-Piece

- Economical and easy to use
- Customized case with built-in wedges for use as a phantom holder
- Measure absorbed dose and monitor scanner output

Computed Tomography Dose Index (CTDI) Phantoms are a key part of your CT Quality Control Program. Measure Absorbed Dose and monitor scanner output with this new and easy to use design.

The Gammex 468 CTDI Phantom was designed to meet specifications outlined by the Food and Drug Administration (FDA 21CFR 1020.33) and the International Electrotechnical Commission (IEC 60601-2-44). The phantom is offered as a 2-piece (Item 682-040) or 3-piece (Item 862-045) telescopic configuration with each configuration consists of nested modules, allowing the user to adapt the phantom to the desired size required by the protocol in use.

CT SIMULATORS, CT PRODUCTS & LASERS

CT DOSE PHANTOM

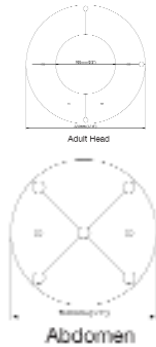
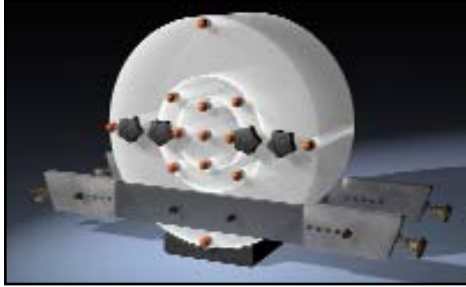

682-007-14, 682-007-15 and 682-007-16

- Abdominal and Adult Head configurations
- PMMA disks and plugs with density of 1.10 g/cc
- 1.31 cm diameter holes sized for standard CT Dose probes
- Nesting PMMA disks minimize storage space
- Compatible with all CT scanners

For all computed tomography systems, the Food and Drug Administration recommends measuring the CT Dose Index. Each section of the CIRS CT Dose Phantom can provide separate dose information. The user can also measure maximum, minimum and mid-range values of the nominal tomographic section thickness when performing dose profile measurements.

The CT Dose Phantom consists of a set of a nesting 15 cm thick solid PMMA disks measuring 16 cm (head) and 32 cm (body) in diameter. The adult head disk is also suitable for pediatric body measurements. Handles on the body and head are provided for ease in handling and maneuverability.

Through holes measuring 1.31 cm in diameter will accommodate standard CT probes. Acrylic rods are provided to plug the holes when not in use. The acrylic rods are machined to receive 1 mm diameter TLD rods.

The CT Dose Phantom is manufactured to comply with the FDA's performance standard, 21 CFR 1020.33 that details the measurement requirements.

An optional Support Bracket can be used to suspend the CT Dose Phantom above the imaging couch and align it along the axis of X-ray tube rotation. This enables the phantom to be used to assess CT dose in helical mode or any mode that requires the extended travel of the imaging couch or a wide beam. This set-up might be used to address the dosimetry approach described in TG111. An additional application of the support bracket is to provide a body to simulate continuous scatter radiation from the patient during helical CT for dose safety measurements inside and outside the exam room.

Replacement acrylic rods are available in 14, 15 or 16 cm long.

Item 682-007 CT Dose Phantom Includes

- | | |
|-------------------------|---------------------------|
| (1) Abdominal Cylinder | (1) Foam Lined Carry Case |
| (1) Adult Head Cylinder | (1) User Guide |
| (9) Acrylic Rods | (1) 48 Month Warranty |

Specifications

Overall Dimensions: 12.5" x 12.5" x 5.5" (31.8 x 31.8 x 15 cm)

Weight: 29 lb (13 kg)

Materials: PMMA

Item #	Description
682-007	CT Dose Phantom
682-009	CT Dose Phantom Support Bracket, Optional
682-007-14	Acrylic Rod CT Probe, 1.31cm Dia. x 14cm Long
682-007-15	Acrylic Rod CT Probe, 1.31cm Dia. x 15cm Long
682-007-16	Acrylic Rod CT Probe, 1.31cm Dia. x 16cm Long

HEAD/BODY CT PHANTOM



- Head Module of a uniform disc of Solid Water® Material
- Ring of Bone mimicking material that mounts around the head module is included
- Body scanning module, body annulus is mounted on the head module.
- The head has 5 tapered cavities which accept tapered inserts and the body annulus ring has 4 cavities, providing a total of 9 test positions.

The Head/Body CT Phantom provides a set of tools for evaluating CT image quality. The main modules are constructed of Solid Water®. This permits testing without the difficulties of filling phantoms with water. The set of standard inserts is sufficient for many users. The Head/Body CT Phantom comes complete with a custom carrying case.

Specifications

Phantom Construction: Solid Water® Material

Inserts Included:

- (9) Uniform Solid Water® inserts for measurement of Noise, CT Number, and Uniformity
- (1) Edge/Contrast Scale Response
- (1) Spatial Resolution (1.50 to 0.4 mm at 100% contrast)
- (1) Low Contrast Detectability (0.6%)
- (1) Alignment Artifact (Aluminum Pin)
- (4) Alignment, Slice Thickness, Phantom Position
- (2) Slice Thickness and Sensitivity Profile 2:1 Slope (26.6° Slope)
- (2) Beam Hardening Artifact (Simulated Bone)
- (6) Linearity

Case Size: 24" x 16" x 8" (70 x 41 x 22 cm)

Weight: 35.7 lb (16.2 kg)

Item #	Description
682-461	Head/Body CT Phantom

CT SIMULATORS, CT PRODUCTS & LASERS

CT ELECTRON DENSITY PHANTOM

Create CT-to-density tables with ease for TPS commissioning



Specifications

Disk Material: Zero HU Solid Water®

Size: 12.9" Dia x 2" H (33 x 5 cm)

Geometric Accuracy Testing: 1mm diameter holes spaced at 50 mm intervals

Weight

Disk and Standard Inserts: 10 lb (4.6 kg)

Phantom with case: 14.5 lb (6.6 kg)

Warranty: One year

1 American Association of Physicists in Medicine Radiation Therapy Committee Task Group 53: Quality Assurance for Clinical Radiotherapy Treatment Planning
2 IAEA TECDOC-1583. Commissioning of Radiotherapy Treatment Planning Systems: Testing for Typical External Beam Treatment Techniques

Tissue Mimicking Insert	Electron Density Relative to Water	Physical Density g/cm ³
Lung (LN-300)	0.29	0.30
Lung (LN-450)	0.40	0.45
Adipose (AP6)	0.90	0.92
Breast	0.96	0.99
Zero HU Solid Water (x4)	0.99	1.02
Brain	1.05	1.05
Liver (LV1)	1.07	1.08
Inner Bone	1.09	1.12
Bone (B200)	1.11	1.15
Bone (CB2-30% Mineral)	1.28	1.34
Bone (CB2-50% Mineral)	1.47	1.56
Cortical Bone (SB3)	1.69	1.82
True Water	1.00	1.00
Optional Titanium (Grade 2)	3.79	4.51
Optional Stainless Steel (Type 316)	6.58	8.00
Optional Aluminum (1100-H14)	2.36	2.71

- Cover a wide range of electron density values
- Help ensure accurate calculations of dose distributions

The American Association of Physicists in Medicine¹ (AAPM) and International Atomic Energy Agency² (IAEA) report that Treatment Planning Systems (TPS) convert Hounsfield Units (HUs) to electron densities for accurate calculations of dose distributions. This is commonly done using electron density reference materials that enable the verification procedure.

The only Solid Water® Insert Holder

The CT Electron Density Phantom consists of a zero HU Solid Water® disk the size of an average pelvis. Sixteen insert chambers in the disk are designed to be used with interchangeable Tissue Mimicking Materials (TMM), used for characterization. Our standard Electron Density Insert Set includes 13 different materials with a wide range of electron density values. Use the electron density inserts to create CT-to-density tables needed for TPS commissioning. The Solid Water disk also contains eight, 1mm diameter holes spaced at 50 mm intervals around the center of the phantom to test the geometric accuracy of the CT scanner. The same Solid Water disk can be used for calcium and iodine inserts to evaluate the Dual Energy characteristics of CT scanners.

Item #	Description
682-467	CT Electron Density Phantom
682-468	Titanium Insert, Optional
682-469	Stainless Steel Insert, Optional
682-470	Aluminum Insert, Optional

ELECTRON DENSITY PHANTOM

Correlate CT Number and Tissue Electron Density

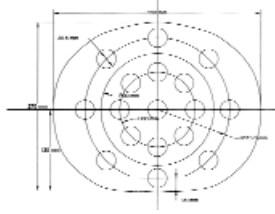

The Electron Density Phantom consists of two nested disks made from Plastic Water®-LR. They can represent both head and abdomen configurations. Nine different tissue equivalent electron density plugs can be positioned at 17 different locations within the scan field. Included is a water vial plug that can be filled with any fluid. Optional distance marker plugs enable quick assessment of the CT scanner's distance measurement accuracy

- Evaluate CT scan data
- Correct for inhomogeneities
- Document relationship between CT number and tissue electron density
- Simulate indicated tissue within the diagnostic energy range
- Quick assessment of distance registration

Because CT scans are used to correct for tissue inhomogeneities in radiotherapy treatment planning, it is important to obtain a precise relationship between CT number (in Hounsfield units) and electron densities. The Electron Density Phantom enables precise correlation of CT data to electron density of various tissues. The phantom is manufactured from CIRS Tissue Equivalent Materials.

Specifications

Overall Dimensions

Electron Density Head Insert: 7" Dia x 1.97" D (180 x 50 mm)

Electron Density Body without Head Insert:
12" W x 10.7" H x 1.97" D (330 x 270 x 50 mm)

Weights

Electron Density Head Insert: approx 2 lb (0.950 kg)

Electron Density Body without Head Insert: approx 4.7 lb (2.1 kg)

Materials: Water and Tissue Equivalent Epoxy Materials

Item #	Description
682-062	Electron Density Phantom

ELCTRON DENSITY PHANTOM ITEM 682-062 INCLUDES

Qty	Description	*Physical Density, (g/cc)	Electron Density x 10 ²³ Electrons/cc	RED (Relative to H ₂ O)
1	Electron Density Head Insert	1.029	3.333	0.998
1	Electron Density Body without Head Insert	1.029	3.333	0.998
2	Lung (Inhale) Equivalent Electron Density Plug	0.20	0.634	0.190
2	Lung (Exhale) Equivalent Electron Density Plug	0.50	1.632	0.489
2	Breast (50% Gland / 50% Adipose) Equivalent Electron Density Plug	0.99	3.261	0.976
2	Solid Trabecular Bone (200 mg/cc HA) Equivalent Electron Density Plug	1.16	3.730	1.117
2	Liver Equivalent Electron Density Plug	1.07	3.516	1.052
2	Muscle Equivalent Electron Density Plug	1.06	3.483	1.043
2	Adipose Equivalent Electron Density Plug	0.96	3.171	0.949
2	Solid Dense Bone (800mg/cc HA) Equivalent Electron Density Plug	1.53	4.862	1.456
1	Solid Dense Bone (1250mg/cc HA) Equivalent Electron Density Plug	1.82	5.663	1.695
1	Water-fillable Electronic Density Plug (Real water data provided)	1.00	3.340	1.000
1	Set of 2 Feet for 682-062			
1	Soft Carry Case			
1	User Guide			
1	48 Month Warranty			

B

CT SIMULATORS, CT PRODUCTS & LASERS

ELCTRON DENSITY PHANTOM OPTIONAL ACCESSORIES

Item	Description	*Physical Density, (g/cc)	Electron Density x 10 ²³ Electrons/cc	RED (Relative to H ₂ O)
682-207	**800 mg/cc HA in Water Equivalent - Core Insert	1.53	4.862	1.456
682-212	**Titanium Rod Core Insert	4.51	12.475	3.735
682-213	Distance Marker Insert	1.029	3.333	0.998
682-216	Water Equivalent Insert	1.029	3.333	0.998
682-217	**1000 mg/cc HA in Water Equivalent - Core Insert	1.66	5.243	1.570
682-218	**1250 mg/cc HA in Water Equivalent - Core Insert	1.82	5.663	1.695
682-219	**ICRU Cortical Bone Equivalent Core Insert***	1.93	5.956	1.780
682-220	**1500 mg/cc HA in Water Equivalent - Core Insert	1.99	6.134	1.837
682-221	**1750 mg/cc HA in Water Equivalent - Core Insert	2.15	6.600	1.976
682-226	Solid Dense Bone (1000 mg/cc HA) Equivalent Electron Density Plug	1.66	5.243	1.570
682-228	Solid Dense Bone (1500 mg/cc HA) Equivalent Electron Density Plug	1.99	6.134	1.837
682-229	Solid Dense Bone (1750 mg/cc HA) Equivalent Electron Density Plug	2.15	6.600	1.976
682-230	Water Equivalent Material Surrounding 6.4mm Diameter Stainless Steel (Alloy 20) Rod Core Electron Density Plug	8.02	23.101	6.917

* Physical Density - The actual physical density of the insert can vary within $\pm 1\%$ of the manufacturing target density.
 Note: CIRS strongly recommends that the user inputs the electron density whenever prompted for material data by the TPS.

** These inserts have a a standard 30 mm diameter and contain a 10 mm diameter core of the indicated reference surrounded by H₂O-equivalent background. Hydroxyapatite (unit mg/cc) in H₂O background Plugs to accommodate chambers, TLD's and film available upon special request. The titanium reference has a unique diameter of 6.35 mm.

*** CIRS Cortical bone reference is based on ICRU Report No.44, and represents approximately 12.2% H₂O, 24.6% protein, 58% mineral (assumed to be Calcium Hydroxyapatite (HA)), and 5.2% monosaccharides. CIRS further offers a series of mineral density references that mimic various HA concentrations in a pure water-equivalent epoxy background matrix.

† Refer to Appendix A for the CIRS cavity and plug code list of available chamber cavities

B

CBCT ELCTRON DENSITY PHANTOM Increase HU Value Confidence for Adaptive RT

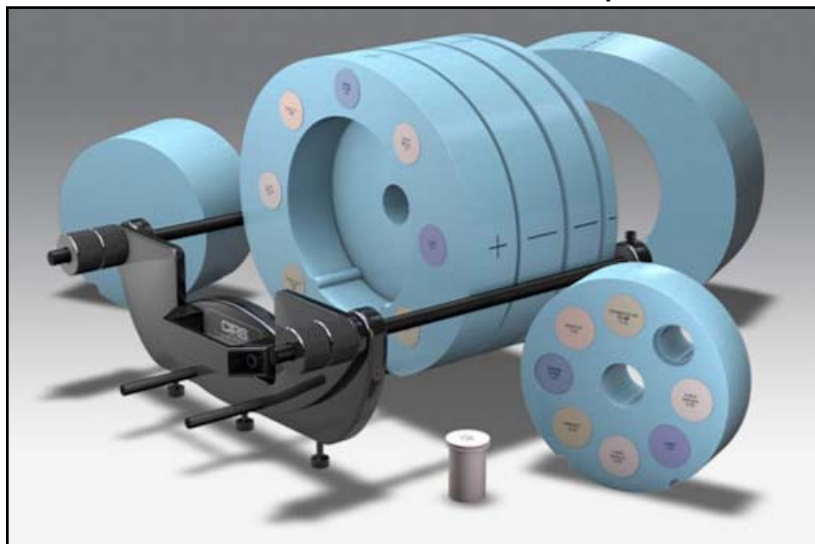

B

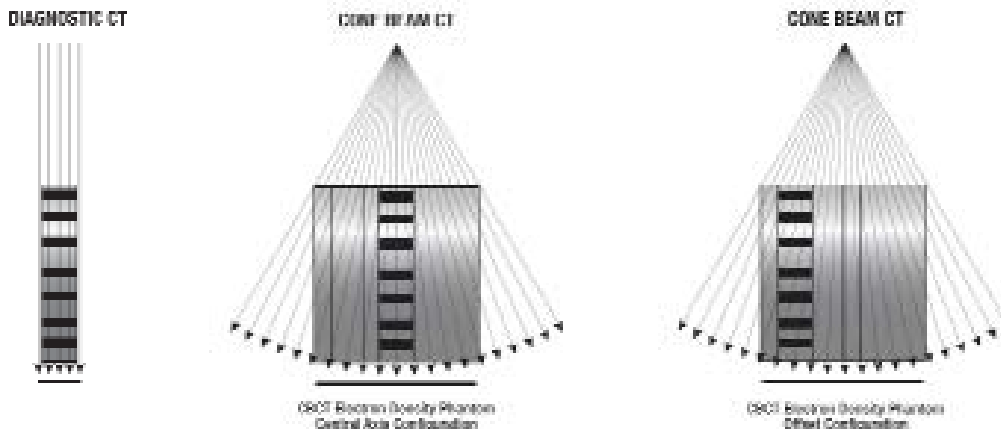

A large number of HU readings can be obtained by placing the electron density plugs in different positions both in central axis and offset configurations. Using the equation of curve fitting for collected values, a CBCT to electron density calibration curve can be calculated.

- Evaluate CT scan data
- Correct for inhomogeneities
- Document relationship between CT number and tissue electron density
- Simulate indicated tissue within the diagnostic and therapeutic energy range
- Quick assessment of distance registration (optional)

The Cone Beam (CBCT) Electron Density Phantom is an extended version of Item 682-062 Electron Density Phantom specifically designed for Cone Beam CT Imaging systems. Preliminary data shows that there may be differences between the HU readings for Diagnostic CT and Cone Beam CT. The geometry of the Cone Beam CT requires additional material and suggests that off central axis measurements should be taken.

The phantom was designed in collaboration with Dr. Peter H. Cossmann, PhD to provide a reliable tool for CT number to electron density calibration in volumetric imaging. Reliable CT

calibration curves help enable treatment plan adaptation directly from Cone Beam CT data. Additionally, the phantom can accommodate any ion chamber for dose measurements and validation of heterogeneity correction based on the corrected CT calibration curve.

The CBCT Electron Density Phantom's size covers geometries for imagers with dimensions of up to 40 cm x 40 cm. It is made of Plastic Water®-LR and contains the same set of tissue equivalent electron density inserts as the standard Item 682-062. Additional interchangeable slabs allow for repositioning of the electron density section off axis.

Specifications

Overall Dimensions: 13" W x 10.6" H x 9.8" D (33 x 27 x 5 cm)

Weight: 40 lb (18 kg)

Materials: Water and Tissue Equivalent Epoxy Resin

Item #	Description
682-200	CBCT Electron Density Phantom

CT SIMULATORS, CT PRODUCTS & LASERS

CBCT ELECTRON DENSITY PHANTOM ITEM 682-200 INCLUDES

Qty	Description	Physical Density (g/cc)	Electron Density Per cc x 10 ²³	RED (Relative to H ₂ O)
1	Electron Density Head Insert	1.029	3.333	0.998
1	Electron Density Body without Head Insert	1.029	3.333	0.998
2	Lung (Inhale) Equivalent Electron Density Plug	0.20	0.634	0.190
2	Lung (Exhale) Equivalent Electron Density Plug	0.50	1.632	0.489
2	Breast (50% Gland / 50% Adipose) Equivalent Electron Density Plug	0.99	3.261	0.976
2	Solid Trabecular Bone (200 mg/cc HA) Equivalent Electron Density Plug	1.16	3.730	1.117
2	Liver Equivalent Electron Density Plug	1.07	3.516	1.052
2	Muscle Equivalent Electron Density Plug	1.06	3.483	1.043
2	Adipose Equivalent Electron Density Plug	0.96	3.171	0.949
2	Solid Dense Bone (800 mg/cc HA) Equivalent Electron Density Plug	1.53	4.862	1.456
1	Solid Dense Bone (1250 mg/cc HA) Equivalent Electron Density Plug	1.82	5.663	1.695
1	Water-fillable Electronic Density Plug (Real water data provided)	1.00	3.34	1.00
1	Set of 2 Feet for 682-062	1.029	3.333	0.998
1	Soft Carry Case for 680-062	1.029	3.333	0.998
1	50 mm Thick Bolus Slab	1.029	3.333	0.998
2	100 mm L x 30 mm dia Background Equivalent Plug	1.029	3.333	0.998
1	12.5 mm Thick Bolus Slab	1.029	3.333	0.998
1	37.5 mm Thick Bolus Slab	1.029	3.333	0.998
1	CBCT Electron Density Phantom -Annulus (100 mm Thick)	1.029	3.333	0.998
1	CBCT Electron Density Phantom-Annulus Solid Insert (100 mm Thick)	1.029	3.333	0.998
1	Holder/Support set for 682-200 & Model 062MQA			
1	Soft Carry Case for 682-200			
1	User Guide			
1	48 Month Warranty			

CUSTOMERS ARE ENCOURAGED TO COMPLETE THEIR ORDER WITH THE PURCHASE OF THE INSERT OPTION LISTED BELOW

Item	Description	*Physical Density, (g/cc)	Electron Density x 10 ²³ Electrons/cc	RED (Relative to H ₂ O)
682-214	†Water Equivalent Chamber Rod with Cavity for Ion Chamber	1.029	3.333	0.998

†Refer to Appendix A for the CIRS cavity and plug code list of available chamber cavities.
If the ion chamber cavity is not specified by customer, phantom is supplied with cavity that accommodates a Farmer type ion chamber.

CBCT ELECTRON DENSITY PHANTOM OPTIONAL ACCESSORIES

Item	Description	*Physical Density, (g/cc)	Electron Density x 10 ²³ Electrons/cc	RED (Relative to H ₂ O)
682-207	**800 mg/cc HA in Water Equivalent - Core Insert	1.53	4.862	1.456
682-212	**Titanium Rod Core Insert	4.51	12.475	3.735
682-213	Distance Marker Insert	1.029	3.333	0.998
682-216	Water Equivalent Insert	1.029	3.333	0.998
682-217	**1000 mg/cc HA in Water Equivalent - Core Insert	1.66	5.243	1.570
682-218	**1250 mg/cc HA in Water Equivalent - Core Insert	1.82	5.663	1.695
682-219	**ICRU Cortical Bone Equivalent Core Insert***	1.93	5.956	1.780
682-220	**1500 mg/cc HA in Water Equivalent - Core Insert	1.99	6.134	1.837
682-221	**1750 mg/cc HA in Water Equivalent - Core Insert	2.15	6.600	1.976
682-226	Solid Dense Bone (1000 mg/cc HA) Equivalent Electron Density Plug	1.66	5.243	1.570
682-228	Solid Dense Bone (1500 mg/cc HA) Equivalent Electron Density Plug	1.99	6.134	1.837
682-229	Solid Dense Bone (1750 mg/cc HA) Equivalent Electron Density Plug	2.15	6.600	1.976
682-230	Water Equivalent Material Surrounding 6.4mm Diameter Stainless Steel (Alloy 20) Rod Core Electron Density Plug	8.02	23.101	6.917

* Physical Density - The actual physical density of the insert can vary within ±1% of the manufacturing target density.
Note: CIRS strongly recommends that the user inputs the electron density whenever prompted for material data by the TPS.

** These inserts have a standard 30 mm diameter and contain a 10 mm diameter core of the indicated reference surrounded by H₂O-equivalent background. Hydroxyapatite (unit mg/cc) in H₂O background Plugs to accommodate chambers, TLD's and film available upon special request. The titanium reference has a unique diameter of 6.35 mm.

*** CIRS Cortical bone reference is based on ICRU Report No.44, and represents approximately 12.2% H₂O, 24.6% protein, 58% mineral (assumed to be Calcium Hydroxyapatite (HA)), and 5.2% monosaccharides. CIRS further offers a series of mineral density references that mimic various HA concentrations in a pure water-equivalent epoxy background matrix.

CT SIMULATORS, CT PRODUCTS & LASERS

GILLIAN QA PHANTOM

Evaluate Image Distortion and Alignment in SPECT/CT, PET/CT and MRI

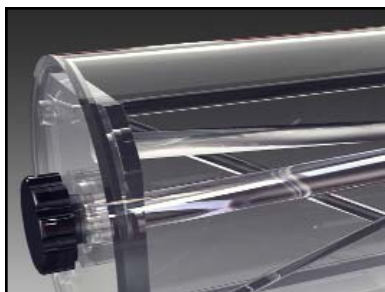

- Compatible with SPECT/CT, PET/CT and MRI
- Check alignment and distortion across the entire imaging field
- Easy to fill and drain
- Allows for independent assessment of equipment function
- Simple geometry allows for quick visual interpretation

Hybrid scanning systems such as SPECT/CT and PET/CT are increasingly being used to improve tumor identification, treatment delivery and monitor treatment effectiveness. By combining images from two different imaging modalities, hybrid scanning systems take advantage of the strengths of individual imaging modalities while minimizing their respective weaknesses. Proper alignment of the fused images is an ongoing concern.

The Gillian QA Phantom provides a simple and cost effective solution to verify image alignment and distortion. The phantom consists of a water tight acrylic cylinder that can be filled with a variety of fluids. Four non-parallel rods of varying diameter run the entire length of the cylinder. Images produced with the phantom can quickly and clearly show if there is any mismatch in the fused images.



CT Image



SPECT Image



Combined Image showing verticle misalignment



Combined Image showing more serious alignment problem

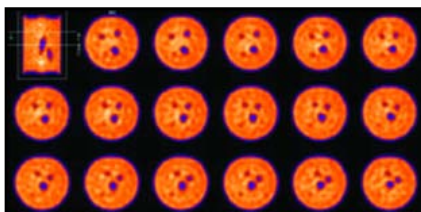

Transverse SPECT of Phantom

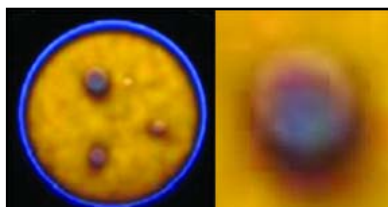

Misalignment detail

Gillian QA Phantom Includes

- (1) Gillian QA Phantom
- (1) Fill Plug
- (1) Drain Adapter
- (1) Vent Port
- (1) Carry Handle with Strap
- (1) User Guide
- 48 Month Warranty

Specifications

Overall Dimensions: 10" x 10.75" x 16" (25.4 x 27.3 x 40.7 cm)

Weight: 14 lb (6.4 kg)

Materials: Acrylic

Rod Diameters: 0.5", 0.75", 0.87" and 1.26" (12.75, 19, 22 and 32 mm)

Item #	Description
682-850	Gillian QA Phantom

B

CT SIMULATORS, CT PRODUCTS & LASERS

AAPM CT PERFORMANCE PHANTOM

Meets guidelines in AAPM Report #1 "Performance Evaluation and Quality Assurance of CT Scanners"

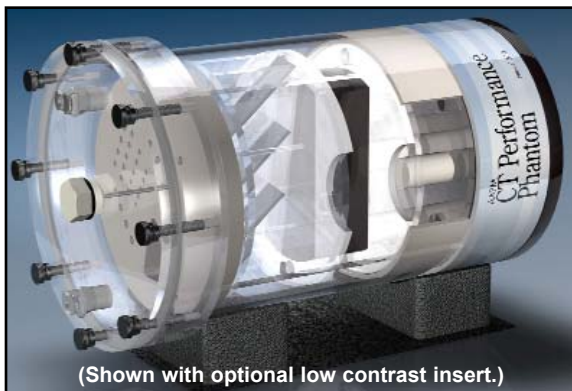

(Shown with optional low contrast insert.)

Specifications

Overall Dimensions: 8.5" OD x 15.5" L (21.6 x 39.4 cm)

Empty Weight: 17.25 lb (7.9 kg)

Materials: PMMA cast tubing 8.5" OD, 8" ID x 12.75" L (21.6 OD, 20.3 ID x 32.4 cm) with removable lid

Item 682-010 Includes

Contrast Test Object

(This option is only available with purchase of the phantom body)
8.5" OD x 2.5" L (21.6 x 6.35 cm) solid acrylic equivalent disk block with 12 fillable cavities 2.25" deep (5.72 cm). Two of each cavity with diameters: 1, 0.75", 0.50", 0.375", 0.25", and 0.125" (2.54, 1.9, 1.27, 0.95, 0.64, 0.32 cm), spaced twice their diameter apart from a center line. Cavities can be easily filled from the outside with dextrose or sodium chloride solutions of various concentration.

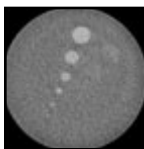

CT Number Linearity Insert

7.5" OD x 2.5" L (19.05 x 6.35 cm) includes 1" diameter (2.54 cm) rods of polyethylene, PMMA (acrylic), polycarbonate, polystyrene, and nylon. Density values (g/cc): polyethylene - 0.95, polystyrene - 1.05, nylon - 1.1, acrylic - 1.19, polycarbonate - 1.20.



Resolution Insert

7.5" OD x 2.5" L (19.05 x 6.35 cm) with acrylic equivalent test object with 8 sets of air thru holes (five holes per set): Diameter of holes is 1.75, 1.5, 1.25, 1.00, 0.75, 0.61, 0.50, and 0.40 mm. Distance between each hole equal to hole diameter. Each row is 5 mm apart. Insert also contains a 0.009" (0.023 cm) stainless steel wire positioned longitudinally for calculation of line-spread function.



Slice Thickness Insert

7.5" OD x 3.5" L (19.05 x 8.89 cm) Contains three 0.02 x 1" (0.064 x 2.54 cm) aluminum strips angled at 45°, positioned on center and aligned vertically.

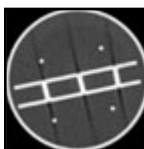

Alignment Pin

0.25" diameter x 3" L (0.64 x 7.62 cm) aluminum pin with threaded attachment to housing cover plate.

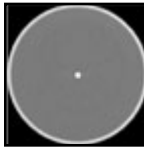

Bone Ring

7.65" ID x 0.2" wall thickness x 2.8" L (19.43 x 0.5 x 7.1 cm) cortical bone ring. Fits over linearity, resolution and slice thickness insert to harden the beam.

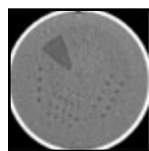

Image Unavailable

User Guide

48 month warranty

Optional Accessories



Item 682-012 Low Contrast Insert

8" OD x 1.18" L (20.3 x 3 cm) proprietary epoxy with CT density 6-10 HU above water. The test object contains a series of water-filled holes from 2.5 to 7.5 mm in diameter, in 0.5 mm steps. For each target size the center-to-center distance between holes is twice the hole diameter.



Item 682-013 Whole Body Resolution and Noise Ring

12" OD x 8.5" ID x 2" L (30.5 x 21.6 x 5.1 cm) fits over phantom housing and contains the same test object as the Resolution Insert, at two locations 90° apart.



Image Unavailable

Item 682-014 TLD Insert

0.5" dia. x 3.5" L (1.3 x 8.9 cm) PMMA rod drilled 3" deep (7.6 cm) to accept TLD's. Can be swapped with Alignment pin in housing cover without removing the cover.



Item 682-015 Low Contrast Insert- Spherical Targets

8" OD x 1.18" L (20.3 x 3 cm) Plastic Water® LR equivalent background. The test object contains spheres 5, 10 & 20 CTU above background and 3 reference plugs for each material used as spheres.

Item 682-021 Carrying Case for 682-010

Custom carry case for easy storage and handling of complete Model 610.

Item #	Description
682-010	AAPM CT Performance Phantom
682-012	Low Contrast Insert
682-013	Whole Body Resolution & Noise Ring

Item #	Description
682-014	TLD Insert
682-015	Low Contrast Insert - Spherical Targets
682-021	Carrying Case

CT SIMULATORS, CT PRODUCTS & LASERS

NUALINE LASERS FOR CT AND LINAC ROOMS



710-993



710-994



710-995



710-998



710-997



- Individual laser line has micro Angular and Transverse adjustments.
- It is extremely easy for installation and routine calibration. Customers may be able to install the lasers without professional help.
- The laser's compact size makes it fit any existing laser systems.
- No tools required.

Item 710-993 GSG1 Green Sagittal Laser

The laser head could pivot in a range of 135° for flexible location (on the ceiling direct above the couch or on a vertical wall).

The laser line has two adjusting knobs. One for tilting laser line and one for moving laser line transversely. The adjustment is tool-less.

Item 710-994 GCR1 Green Crosshair Laser

The laser head could be adjusted over the mounting base for laser center alignment.

Each laser line has two adjusting knobs. One for tilting laser line and one for moving laser line transversely. The adjustment is tool-less.

Item 710-995 SG1 Red Sagittal/Backpointer Laser

The laser head could pivot in a range of 135° for flexible location (on the ceiling direct above the couch or on a vertical wall).

The laser head could be adjusted over the mounting base for laser center alignment.

The laser line has two adjusting knobs. One for tilting laser line and one for moving laser line transversely. The adjustment is tool-less. This feature brings easiness for both installation and

routing calibration.

This laser (without a line generator lens) could also be used as a back-pointer.

Item 710-997 CR2 Red Crosshair Laser

Model CR2 is designed for small treatment rooms with diagonal layout. The laser head has a pivoting range of 135°. No additional mounting bracket is needed.

Two internal screws for adjusting cross hair line (as a whole) horizontally and vertically. The line titling is done by rotate the laser head over the mounting base.

Item 710-998 CR3 Red Crosshair Laser

The laser head could be adjusted over the mounting base for laser center alignment.

Each laser line has two adjusting knobs. One for tilting laser line and one for moving laser line transversely.

The adjustment is tool-less. This feature brings easiness for both installation and routing calibration.

Specifications

Electrical power consumption

Red laser: <0.2A / 7VDC.

Green laser: <1A / 3VDC

FDA Compliance

Nualine laser meets FDA requirement of class I medical device. Nualine laser devices are listed with FDA and the company is registered with FDA. A warning label on the device meets FDA code 1040.10.

Item #	710-993	710-994	710-995	710-997	710-998
Model	GSG1	GCR1	SG1	CR2	CR3
Description	Green Sagittal	Green Crosshair	Red Sagittal/Backpointer	Red Crosshair	Red Crosshair
Wave Length	532nm DPSS	532nm DPSS	635nm	635nm	635nm
Line Width	< 1 mm	< 1 mm	< 1 mm	< 1 mm	< 1 mm
Range	4 -15' (1.2 - 4.5 m)	4 -15' (1.2 - 4.5 m)	6 -12' (1.8 - 3.7 m)	6 -12' (1.8 - 3.7 m)	6 -12' (1.8 - 3.7 m)
Focus	Adjustable	Adjustable	Fixed	Fixed	Fixed
Size	3" x 5.9" x 2" (7.6 x 15 x 5 cm)	4" x 5.9" x 1.8" (10.2 x 15 x 4.5 cm)	3.2" x 2.75" x 2.3" (8.1 x 7 x 5.8 cm)	3.5" x 3" x 2.3" (8.9 x 7.6 x 5.8 cm)	4.5" x 4" x 2" (11.4 x 10.2 x 5 cm)
Weight	15 oz (425 gm)	28.3 oz (800 gm)	10.6 oz (300 gm)	12.9 oz (365 gm)	19.5 oz (550 gm)

B

CT SIMULATORS, CT PRODUCTS & LASERS

LAP ASTOR LASERS

Laser Systems for Patient Alignment



ASTOR lasers come standard with adjustable tilting brackets allowing for rotation up to 45°. Due to its very small size LAP lasers are ideal for mounting in small and hard to reach places.

Specifications

ASTOR Red

Line Width Up to 4 m Distance: <1mm
Line Length at 3 m / 10 ft Distance: 13.1 ft (4 m)
Laser Type: Diode
Wavelength: 635 nm
Output Power: <1mW
Supply Voltage: 100 - 240 VAC
Internal Voltage: 5 V DC
Power Consumption: 1 W
Operating Temperature: 0-40°C
Dimensions: 7.4" H x 3.4" W x 3.6" D (188 x 86 x 93 mm)
Weight: 3.3 lb (1.5 kg)
Adjustment Accuracy at Isocenter: ± 0.5 mm

ASTOR Green

Line Width Up to 4 m Distance: <1mm
Line Length at 3 m / 10 ft Distance: 10 ft (3 m)
Laser Type: Diode Pumped Solid State
Wavelength: 532 nm
Output Power: <1mW
Supply Voltage: 100 - 240 VAC
Internal Voltage: 5 V DC
Power Consumption: 10 W
Operating Temperature: 15-30°C
Dimensions: 8.7" H x 4.3" W x 4.0" D (221 x 110 x 101 mm)
Weight: 5 lb (2.4 kg)
Adjustment Accuracy at Isocenter: ± 0.5 mm

ASTOR room lasers are high precision tools for patient setup and improved treatment quality.

Precise, accurate and reproducible patient positioning is paramount to the success of radiation therapy treatments. Combined with on board imaging systems the patient positioning lasers provide an interface between the patient and the treatment delivery system. Room lasers are necessary tools for aligning the patient, daily reference isocenter adjustments, and assuring optimized isocenter accuracy for your linear accelerator.

LAP room lasers are equipped with extremely stable highly polished and extra flattened plane glass windows. They have a very low and constant dispersion to assure a fine and sharply edged laser line. The glass is anti-reflective to avoid interference from the beam.

LAP UltraLine® is the result of the advanced mechanical systems and the unique optoelectronics used to generate and align laser lines for medical applications.

Adjustments ASTOR red room lasers

- Rotate vertical and horizontal line
- Parallel line translation right/left and up/down
- Plane tilt horizontal and vertical (without cover removal)
- Focus vertical and horizontal line

ASTOR Green forms a cross by using one singular element: a prism, manufactured to split one beam into two perpendicular lines. This configuration allows LAP ASTOR GREEN room lasers to use one window only. As the beam forming takes place before the prism and its surface antireflection coating is selected for the laser's wavelength, focussing of the crosshair has virtually no influence on rectangularity or brightness distribution – a real superprism. Due to the singular prism, focussing of both lines of the laser cross is handled by a single adjustment screw.

Adjustments ASTOR green room lasers

- Rotation clockwise and counterclockwise
- Parallel line translation right/left and up/down
- Plane tilt horizontal and vertical (without cover removal)
- Focus crosshair



BACKPOINTER LASER



The solid state diode Backpointer laser comes in either red or green. The small housing of the red diode Backpointer has been specially designed to replace the fiber optic head of the older generation.

Item	LAP Lasers
711-001	ASTOR Red - Crosshair
711-002	ASTOR Red - Line
711-010	ASTOR Green - Crosshair
711-012	ASTOR Green - Line
711-025	Backpointer Laser - Red
711-026	Backpointer Laser - Green

B

LAP APOLLO LASERS Laser Systems for Patient Alignment



APOLLO room lasers are high precision tools for patient setup and improved treatment quality.

Precise, accurate and reproducible patient positioning is paramount to the success of radiation therapy treatments. Combined with on board imaging systems the patient positioning lasers provide an interface between the patient and the treatment delivery system. Room lasers are necessary tools for aligning the patient, daily reference isocenter adjustments, and assuring optimized isocenter accuracy for your linear accelerator. The LAP APOLLO lasers deliver the highest precision, accuracy and reproducibility: with their long lines and 6 degrees of remote controlled freedom they are ideally suited for today's advanced treatments.

Key points of APOLLO room lasers

- Longer laser lines for improved patient positioning
- Clockwork precision motors and gears
- Full 6 degrees of freedom adjustment via wireless IR RC
- Compact design combined with the finest optoelectronics
- Superior aluminium construction, extruded and CAM machined

LAP room lasers are equipped with extremely stable highly polished and extra flattened plane glass windows. They have a very low and constant dispersion to assure a fine and sharply edged laser line. The glass is anti-reflective to avoid interference from the beam.

LAP APOLLO avoids the pitfalls of two separate lines forming a cross by using one singular element: a prism, manufactured to split one beam into two perpendicular lines. This configuration allows LAP APOLLO room lasers to use one window only, making them the most compact systems. As the beam forming takes place before the prism, and its surface antireflection coating is selected for the laser's wavelength, focussing of the crosshair has virtually no influence on rectangularity or brightness distribution – a real superprism. Due to the singular prism, focussing of both lines of the laser cross is handled by a single adjustment drive.

During the installation of the treatment machine the APOLLO lasers are adjusted so that their respective laser lines precisely intersect the isocenter. If over time further adjustments are required to achieve accuracy and performance related to the true isocenter of the treatment machine, the APOLLO lasers offer an advanced remote controlled system that provides fast and simple adjustments from a convenient handheld remote control.

FULL FUNCTION REMOTE CONTROL

- Line rotation clockwise and counterclockwise
- Parallel line translation right/left and up/down
- Plane tilt horizontally and vertically
- Focus control

APOLLO lasers come standard with adjustable tilting brackets allowing for rotation up to 45°. Due to its very small size LAP lasers are ideal for mounting in small and hard to reach places.

Specifications

APOLLO Red

Line Width Up to 4 m Distance: <1mm
Line Length at 3 m / 10 ft Distance: 12 ft (4 m)
Laser Type: Laser Diode
Wavelength: 635 nm
Output Power: <1mW
Supply Voltage: 100 - 240 VAC
Internal Voltage: 5 V DC
Power Consumption: 1 W
Operating Temperature: 0-40°C
Dimensions: 8.7" H x 4.3" W x 4.1" D (221 x 110 x 104 mm)
Weight: 5.7 lb (2.6 kg)

ASTOR Green

Line Width Up to 4 m Distance: <1mm
Line Length at 3 m / 10 ft Distance: 10 ft (3 m)
Laser Type: Diode Pumped Solid State
Wavelength: 532 nm
Output Power: <1mW
Supply Voltage: 100 - 240 VAC
Internal Voltage: 5 V DC
Power Consumption: 10 W
Operating Temperature: 15-30°C
Dimensions: 8.7" H x 4.3" W x 4.1" D (221 x 110 x 104 mm)
Weight: 5.7 lb (2.6 kg)



BACKPOINTER LASER



The solid state diode Backpointer laser comes in either red or green. The small housing of the red diode Backpointer has been specially designed to replace the fiber optic head of the older generation.

Item	LAP Lasers
711-015	APOLLO Red - Crosshair
711-017	APOLLO Red - Line
711-020	APOLLO Green - Crosshair
711-022	APOLLO Green - Line
711-025	Backpointer Laser - Red
711-026	Backpointer Laser - Green

CT SIMULATORS, CT PRODUCTS & LASERS

LAP LASER APOLLOBLUE Advanced Laser System for Patient Alignment

B



APOLLOBLUE ROOM LASERS – HIGH PRECISION TOOLS FOR PATIENT SETUP AND IMPROVED TREATMENT QUALITY

Precise, accurate and reproducible patient positioning is paramount to the success of radiation therapy treatments. Combined with on board imaging systems the patient positioning lasers provide an interface between the patient and the treatment delivery system. Room lasers are necessary tools for aligning the patient, daily reference isocenter adjustments, and assuring optimized isocenter accuracy for your linear accelerator. The LAP APOLLOblue lasers deliver the highest precision, accuracy and reproducibility: with their long lines and 6 degrees of remote controlled freedom they are ideally suited for today's advanced treatments.

Key points blue vision laser:

- Clearest lines
- Finest lines
- Human skin reflects blue light better

WHY BLUE LASERS?

The human retina contains approximately 120 millions rods and only 6 millions cone receptors, which, when stimulated by light, send signals to the brain. These signals are subsequently interpreted as vision. Rods and cones are not equally sensitive to visible wavelengths of light. Unlike the cones, rods are more sensitive to blue light and are not sensitive to wavelengths greater than 640 nm, the red fraction of the visible spectrum. If the human eye is exposed to less light than normal, the reception changes from photopic to scotopic sight. This increases the sensitivity of the human eye to blue light by a factor of 10 or more, whereas sensitivity for green increases only by a factor of 2 or less and for red it is reduced to less of even more.

The best working environment for blue lasers is a dimmed room. This is the case in a CT or linac room.

Because of the shorter wavelength, blue laser light penetrates organic materials and skin less than red or green laser light. Scattering and diffuse reflections such as interactions with oxygenated blood are reduced. The longer wavelength of red and green lasers, leads correspondingly, to an increase in the penetration depth.

LINE QUALITY MAKING THE DIFFERENCE

When using a treatment or imaging system the isocenter must be precisely verified. The LAP APOLLOblue positioning lasers project ultra-fine laser lines denoting the isocenter of these systems so that the patient can be quickly and accurately placed on the treatment couch in a reproducible position. LAP APOLLOblue lasers set the highest standard when it comes to line quality, stability, reliability and ease of use.

EASE OF ADJUSTMENT

During the installation of the treatment machine the APOLLOblue lasers are adjusted so that their respective laser lines precisely intersect the isocenter. If over time further adjustments are required to achieve accuracy and performance related to the true isocenter of the treatment machine, the APOLLOblue lasers offer an advanced remote controlled system that provides fast and simple adjustments from a convenient handheld remote control.

Specifications

Line width (up to 4 m distance): < 0.5 mm (FWHM)

Line length (at 3 m distance): 3 m

Laser type: Diode

Wavelength: 450 nm

Output power: < 1 mW

Laser class: 2

Supply voltage: 100 - 240 VAC

Internal Voltage: 24 VDC

Power consumption: 1 W

Operating Temperatur: 15-30°C

Dimensions: 8.7" H x 4.3" W x 3.9" D (221 x 110 x 100 mm)

Weight: 5.7 lb (2.6 kg)



Item	Description
711-027	LAP Laser APOLLOBLUE - Crosshair
711-028	LAP Laser APOLLOBLUE - Line

MICRO™ DIODE LASER

Ultra Compact Diode Laser



- Compact size
- Superior line width and range
- Available in Crosshair and Sagittal
- Red, Green or Blue diode colors
- Economical

Small in size but not in capabilities. The new “micro” diode laser family offers an economical alternative to conventional laser systems used for alignment purposes. The “micro” has dimensions that are considerably smaller than other fixed lasers. This makes it easy to fit into tight locations and reduces the chance of hitting the laser and knocking it out of alignment. The new design also makes it simple and easy to mount and focus or align.

Preference for laser diode colors is important based on patient demographics and what colors are best viewed by your personnel. The “micro” comes with a choice of either Red, Green or Blue colors to allow you the maximum site flexibility. These lasers can also be easily changed to one of the other colors by buying the other color diode and simply changing the diode and recalibrating. This allows for a color change at minimal cost without having to purchase all new lasers.

Its composite housing and esthetically pleasing design fit right in with your treatment room’s comforting appearance. The non-metallic housing cover keeps the weight of the entire unit below 800 grams.

The many features of the “micro” laser provide a wide range of benefits including:

- Compact design permitting the laser to blend in well with the room and to remain out of the way
- Utilize different diode colors to simplify marking recognition
- Less complicated and faster installations
- Simple design makes alignment and focus adjustments quick and easy if they need to be performed
- Composite, non-metallic housing cover reduces the laser’s weight
- The economical feature of the “micro” laser makes outfitting a room with new lasers easier on your budget.

Specifications

Laser Beam Output

Laser Output: <1.0 mW (each beam)

Range minimum: Up to 6.0 m (20 ft)

Line Width: ≤ 0.5 mm @ 3 m

Line Length: ≥1.0 m @ 3 m

Drift: Not measurable

WaveLength: Red: 635 nm

Green: 515 nm

Blue: 450 nm

Visibility: Clearly visible in strong ambient light

Laser Beam Adjustment

Coarse Planar: ±7.6 mm (0.3") horizontal and vertical

Coarse Angular: ±25° horizontal

Fine Angular: ±3.5° horizontal and vertical

Line Rotation: ±180°

Laser Dimensions

Overall Size: 3.63" W x 5.75" L x 3.0" D (9.2 x 14.6 x 7.6 cm)

Weight: 1.6 lb (725 gm)

Power Supply: 110/240 VAC, 50-60 Hz, 0.3 A (Laser unit includes various adapters for US and international use)

Item	Micro Diode Lasers
711-300	Crosshair Red
711-303	Crosshair Green
711-306	Crosshair Blue
711-310	Sagittal Red
711-313	Sagittal Green
711-316	Sagittal Blue

Room packages of 3 or 4 lasers are also available

B